

QUADRAX /TWINAX CONNECTOR SERIES

MIL-DTL-38999 Style Connectors

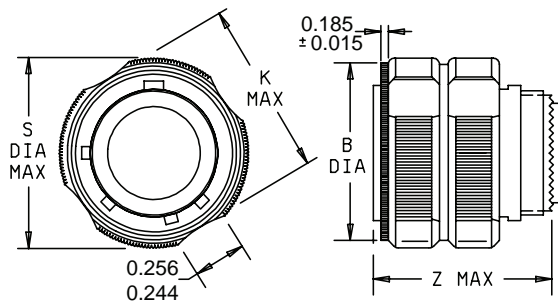

► MIL-DTL-38999 TWINAX/QUADRAX PLUG



Shell Size	B Dia. +.008 - 0	K Max	S Dia. Max	Z Max
9	0.724	0.748	0.858	1.22
11	0.831	0.862	0.984	
13	1.000	1.028	1.157	
15	1.13	1.154	1.28	
17	1.268	1.291	1.406	
19	1.374	1.398	1.516	
21	1.5	1.524	1.642	
23	1.618	1.642	1.768	
25	1.744	1.768	1.89	

► MIL-DTL-38999 TWINAX/QUADRAX RECEPTACLE

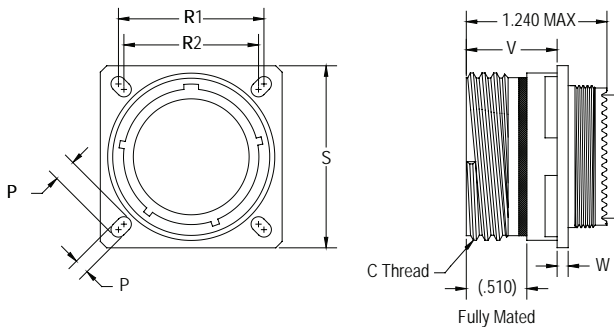

Shell Size	C Thread .1 Pitch .3 Lead	P ±.008	R1 BSC	R2 BSC	V Max +0.00 -0.05	W Max	PP Max ±.008	S ±.012
9	0.625	0.128	0.719	0.594	0.820	0.098	0.216	0.937
11	0.75		0.812	0.719			0.194	1.031
13	0.875		0.906	0.812			0.173	1.126
15	1.000		0.969	0.906			0.194	1.220
17	1.188		1.062	0.969			0.173	1.311
19	1.25		1.156	1.062			0.194	1.437
21	1.375	0.154	1.250	1.156	0.790	0.126	0.242	1.563
23	1.500		1.375	1.250			1.689	
25	1.625		1.500	1.375			1.811	

▶ SIZE 8 QUADRAX PIN CONTACT 100 OHM

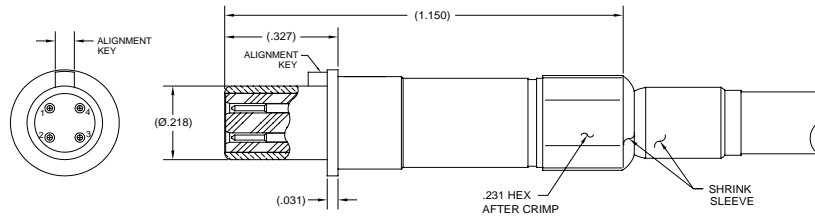

PART NUMBER	OHMS	CABLE TYPE	CABLE
019635-0001	100	Differential Quad	540-1183-000
019635-0010	100	Differential Quad	540-1209-000

▶ SIZE 8 QUADRAX SOCKET CONTACT 100 OHM

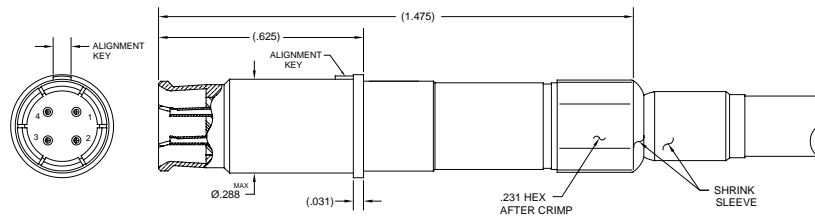

PART NUMBER	OHMS	CABLE TYPE	CABLE
019535-0001	100	Differential Quad	540-1183-000
019535-0010	100	Differential Quad	540-1209-000

▶ SIZE 8 QUADRAX/TWINAX RECEPTACLE PC TAIL CONFIGURATION

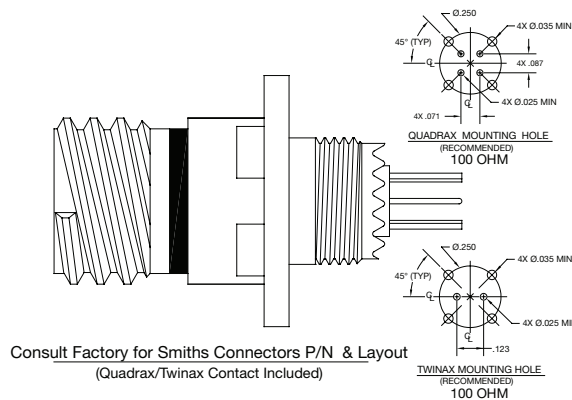

▶ SIZE 8 TWINAX PIN CONTACT 100 OHM

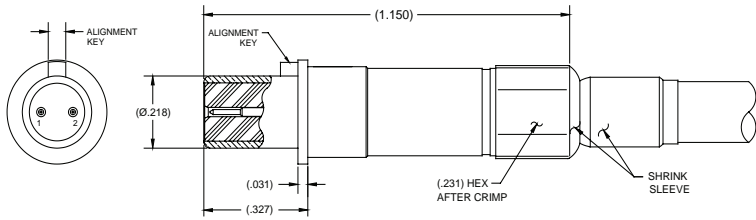

PART NUMBER	CABLE TYPE	CABLE
019634-0011	Differential Twinax	540-1167-000
019634-0012	Flexible Twinax	540-1161-000
019634-0013	Differential Twinax	540-1153-000

▶ SIZE 8 TWINAX SOCKET CONTACT 100 OHM

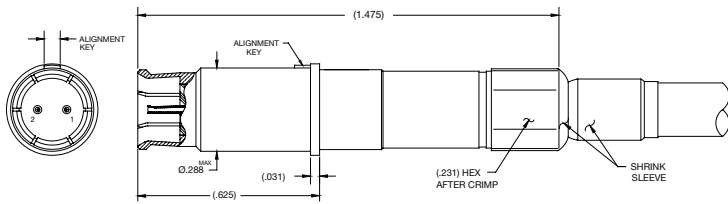

PART NUMBER	CABLE TYPE	CABLE
019534-0011	Differential Twinax	540-1167-000
019534-0012	Flexible Twinax	540-1161-000
019534-0013	Differential Twinax	540-1153-000

▶ SIZE 8 TWINAX PIN CONTACT 150 OHM

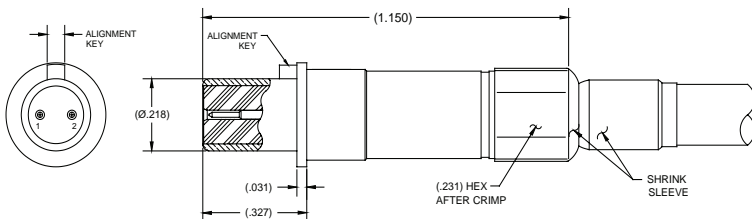

PART NUMBER	CABLE TYPE	CABLE
019634-0014	Differential Twinax	540-1099-000
019634-0020	Differential Twinax	540-1236-000

▶ SIZE 8 TWINAX SOCKET CONTACT 150 OHM

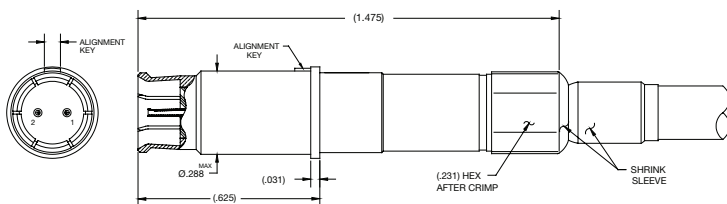

PART NUMBER	CABLE TYPE	CABLE
019534-0014	Differential Twinax	540-1099-000
019534-0020	Differential Twinax	540-1236-000

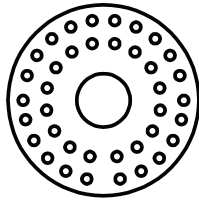

17-2 T/Q
1 #8
38 #22D

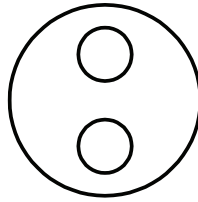

17-82 T/Q
2 #8

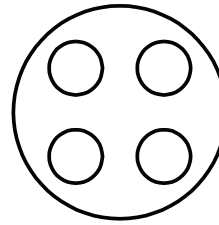

19-4 T/Q
4 #8

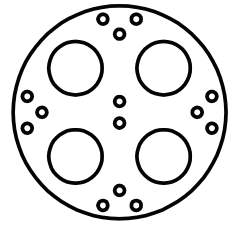

19-18 T/Q
4 #8
14 #22D

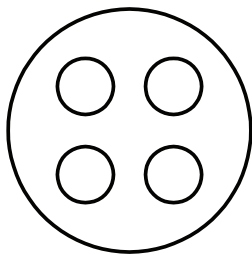

21-75 T/Q
4 #8

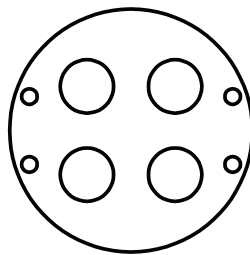

21-4T4 T/Q
4 #8
4 #22D

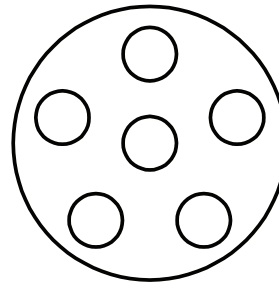

23-6 T/Q
6 #8

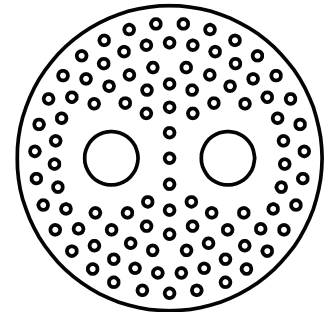

25-7 T/Q
2 #8
97 #22D

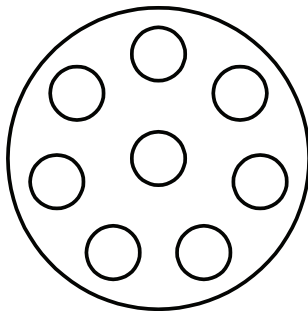

25-8 T/Q
8 #8

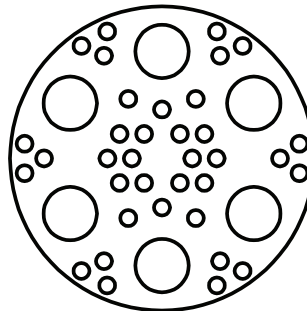

25-17 T/Q
6 #8
36 #22D

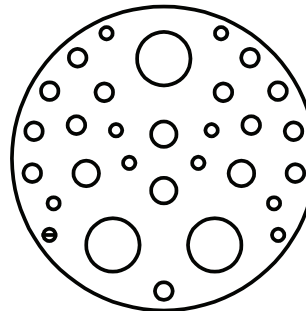

25-20 T/Q
3 #8 / 13 #16
4 #12 / 10 #20

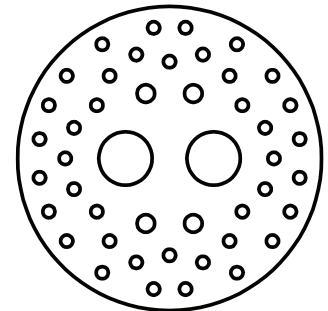

25-46 T/Q
2 #8
4 #16
40 #20

Note 1: Size #8 Twinax/Quadax (T/Q) Cavities are Anti-Rotational

Note 2: Size #8 Twinax/Quadax contact cavities are common ground to the connector shell with a ground resistance of 10 milliohms maximum or insulated from common ground. Consult factory for details, please specify preference (common ground or insulated).

Note 3: Mixed signal contacts are insulated from common ground. Consult factory for unique grounding and/or filtering requirements.

Note 4: Use removal tool M81969/14-12 to remove size 8 contacts.

Smiths Connectors provides specialty, enhanced performance connectors and cable assemblies and as such does not currently offer circular, rack and panel, or D-subminiature connectors that are listed on military standard Qualified Products Lists (QPL) per applicable detail specification sheets. Smiths Connectors' connectors are fully intermateable with applicable QPL products and meet the applicable requirements of all military standards listed in this catalog.

▶ **SIZE 10 QUADRAX PIN CONTACT 100 OHM**

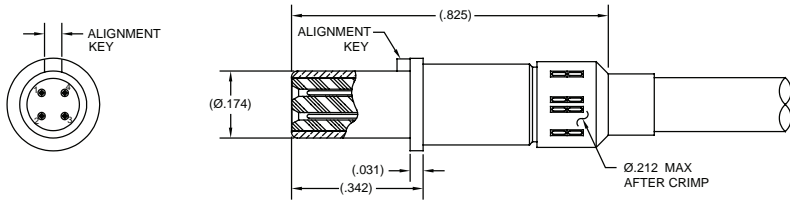

PART NUMBER	CABLE TYPE	CABLE
018835-2100	Differential Quadrax	540-1229-000

▶ **SIZE 10 QUADRAX SOCKET CONTACT 100 OHM**

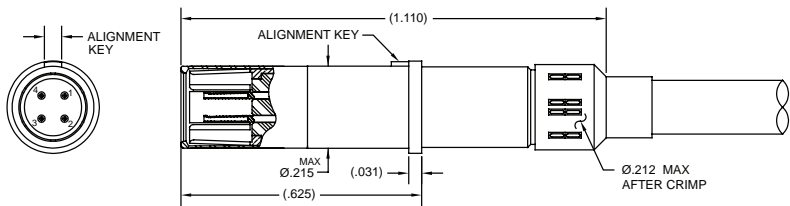

PART NUMBER	CABLE TYPE	CABLE
018935-2100	Differential Quadrax	540-1229-000

▶ **SIZE 10 TWINAX PIN CONTACT 100 OHM**

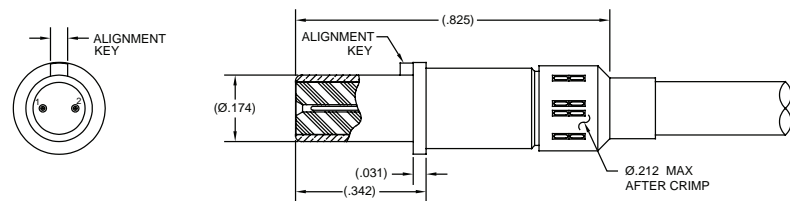

PART NUMBER	CABLE TYPE	CABLE
018834-2100	Differential Twinax	540-1210-000

▶ **SIZE 10 TWINAX SOCKET CONTACT 100 OHM**

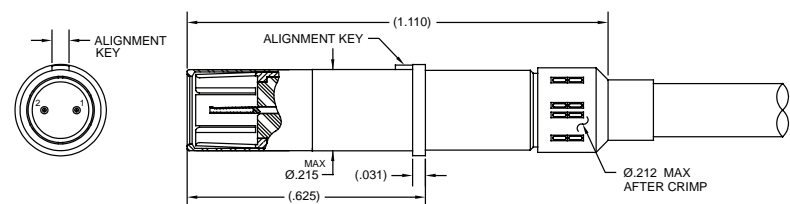

PART NUMBER	CABLE TYPE	CABLE
018934-2100	Differential Twinax	540-1210-000

SIZE 10 PC TAIL RECEPTACLE

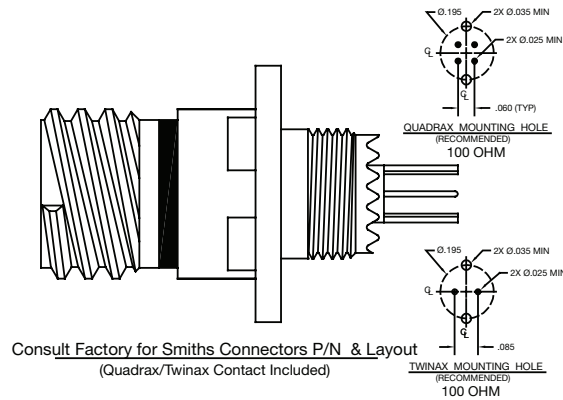

SIZE 10T/QX TWINAX/QUADRAX CONTACT LAYOUTS FOR STANDARD MIL-DTL-38999 SHELLS

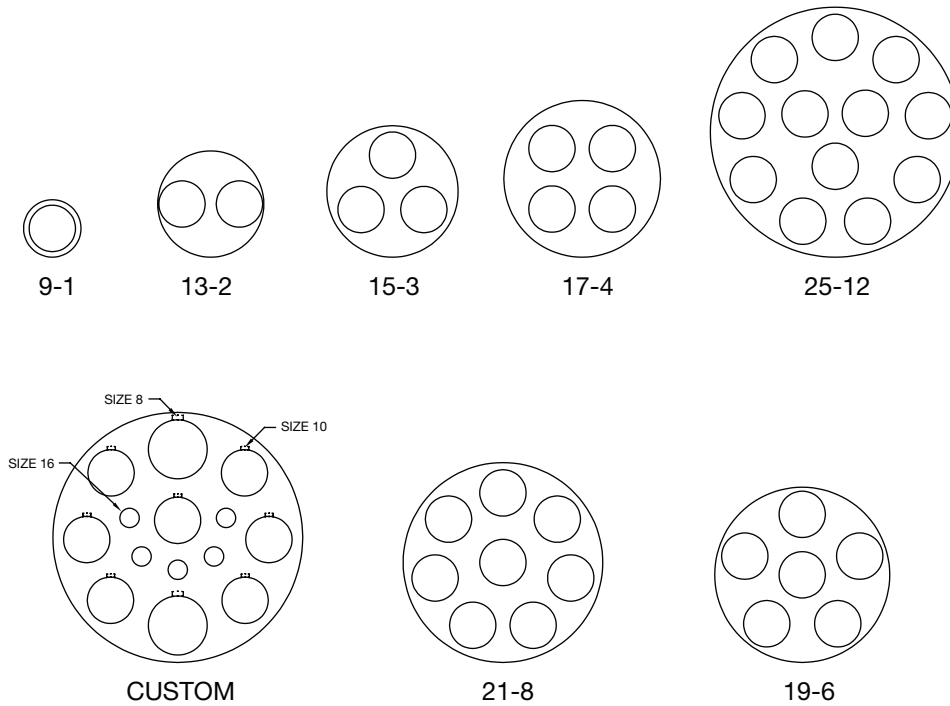

- Notes:
- Arrangements are unique Smiths Connectors layouts designed for MIL-DTL-38999 connector formats
 - Twinax/Quadrax contact cavities are common ground to the connector shell
 - Size 10 Twinax/Quadrax (T/QX) cavities are anti-rotational
 - To remove Size 10 Twinax/Quadrax contacts use removal tool M81969/14-05

► MIL-DTL-38999 SIZE 11 PIN INSERT QUAD PLUG TO PLUG CABLE ASSEMBLY

Y	Polarization
1	N
2	A
3	B
4	C
5	D
6	E

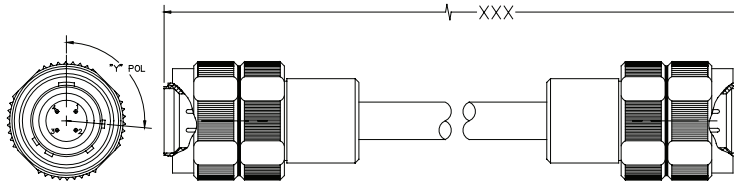

Y = Connector Polarization
XXX = Cable Length in Inches

PART NUMBER	CABLE TYPE	CABLE
02990Y-2XXX	Differential Quad	540-1138-000
02990Y-3XXX	Differential Quad	540-1143-000

► MIL-DTL-38999 SIZE 11-4 CONNECTOR SAVER QUAD CONFIGURATION

Part Number	Polarization
013500-4100	N
013500-4101	A
013500-4102	B
013500-4103	C
013500-4104	D
013500-4105	E

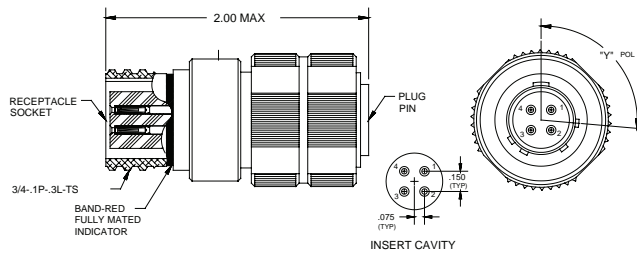

► MIL-DTL-38999 SIZE 25 FOUR WAY SOCKET INSERT QUAD PLUG

Y	Polarization
1	N
2	A
3	B
4	C
5	D
6	E

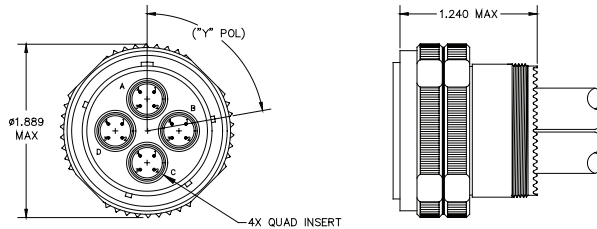

PART NUMBER	CABLE TYPE	CABLE
01340Y-2000	Differential Quad	540-1138-000
01340Y-2001	Differential Quad	540-1143-000

Y = Connector Polarization

Please specify cable length when ordering

► BOX MOUNT RECEPTACLE PIN INSERT 25-8 PT* TO 8 R/A TWINAX CABLES TO OPEN LEAD

Y	Polarization
1	N
2	A
3	B
4	C
5	D
6	E

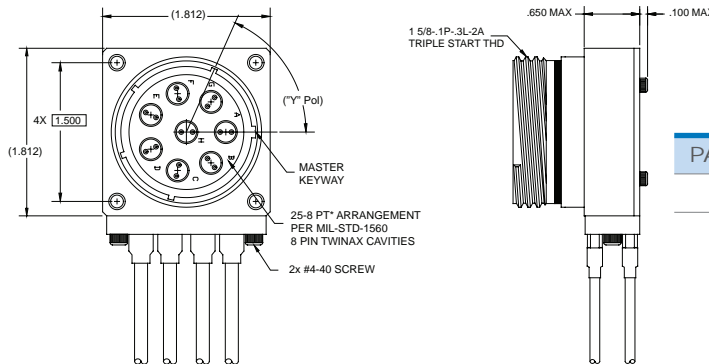

PART NUMBER	CABLE TYPE	CABLE
02370Y-1XXX	Differential Twinax	540-1099-000

Y = Connector Polarization
XXX = Cable Length in Inches

Please specify cable length when ordering

* Connector Receptacle is supplied fully loaded with twinax pin contacts terminated to differential pair twinax cable to open lead (all cavities included).

HOW TO ORDER



1 ▶ PREFIX

2 ▶ SERIES

A I **B** III **C** IV

3 ▶ SHELL STYLE

J JAM NUT (REAR MOUNT) **W** WALL MOUNT (FRONT OR REAR MOUNT) **P** PLUG

4 ▶ MATERIAL/PLATING

C ALUMINUM ALLOY/CADMIUM OVER NICKEL **N** ALUMINUM ALLOY/ELECTROLESS NICKEL **S** STAINLESS STEEL/PASSIVATED
CC COMPOSITE/CADMIUM OVER NICKEL **CN** COMPOSITE/ELECTROLESS NICKEL

Consult factory for alternate plating options

5 ▶ SHELL SIZE

9 THRU **25**

6 ▶ INSERT ARRANGEMENTS

See page 58 for Size 8 layouts
 See page 60 for Size 10 layouts

7 ▶ CONTACT TYPE

P PIN **S** SOCKET

8 ▶ CONTACT TERMINATION

P PC TAIL **C** CRIMP

9 ▶ POLARIZATION

N, A, B, C, D, E

Notes:

1. Twinax/Quadax Crimp Contacts are sold separately
2. Twinax/Quadax PC Contacts are included
3. Smiths Connectors' connectors are fully intermateable with all slash sheet part Smiths Connectors does not; however, offer standard QPL slash sheet part #'s MIL-DTL circular and rack & panel connectors because of the application specific nature Smiths Connectors' product offerings.

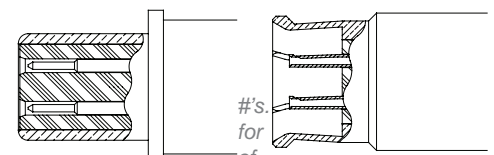

Quadrax Reverse Gender Interface

HOW TO ORDER



1 ▶ CONNECTOR #1

2 ▶ CABLE GROUP

Flexible Twinax

1 = M17/176-00002

2 = 540-1086-000

3 = 540-1161-000

Differential Twinax

6 = 540-1099-000

7 = 540-1114-000

8 = 540-1153-000

34 = 540-1167-000

38 = 540-1210-000

39 = 540-1236-000

Differential Quadrax

9 = 540-1138-000

10 = 540-1143-000

36 = 540-1183-000

37 = 540-1235-000

42 = 540-1209-000

41 = 540-1229-000

3 ▶ CONNECTOR #2 OL for Open Lead

4 ▶ CABLE LENGTH IN INCHES (XXX)

FLEXIBLE TWINAX CABLES					
CABLE GROUP	CABLE DESIGNATION	IMPEDANCE (OHMS)		JACKET	CONDUCTOR (DIA)
1	M17/176-00002	77		0.129"	0.024"
2	540-1086-000	98		0.143"	0.019"
3	540-1161-000	100		0.130"	0.024"
DIFFERENTIAL PAIR TWINAX CABLES					
6	540-1099-000	Differential: 150	Sig. to Shield: 75	0.097" x 0.160"	0.014" Stranded
7	540-1114-000	Differential: 150	Sig. to Shield: 75	0.138" x 0.224"	0.020" Solid
8	540-1153-000	Differential: 100	Sig. to Shield: 50	0.085" x 0.130"	0.019" Stranded
34	540-1167-000	Differential: 100	Sig. to Shield: 50	0.117" x 0.160"	0.0233" Stranded
38	540-1210-000	Differential: 100	Sig. to Shield: 50	0.132"	0.019"
39	540-1236-000	Differential: 150	Sig. to Shield: 75	0.191"	0.019"
DIFFERENTIAL QUADRAX CABLES					
9	540-1138-000	Differential: 150	Sig. to Shield: 75	0.290"	0.032"
10	540-1143-000	Differential: 150	Sig. to Shield: 75	0.190"	0.020"
36	540-1183-000	Differential: 100	Sig. to Shield: 50	0.160"	0.024"
37	540-1235-000	Differential: 100	Sig. to Shield: 50	0.108"	0.012"
40	540-1209-000	Differential: 100	Sig. to Shield: 50	0.190"	0.029"
41	540-1229-000	Differential: 100	Sig. to Shield: 50	0.137"	0.019"



SMITHS CONNECTORS GLOBAL SUPPORT

AMERICAS

info.us@smithsconnectors.com

Costa Mesa, CA

1.714.371.1100

Hudson, MA

1.978.568.0451

Kansas City, KS

1.913.342.5544

EUROPE

France

33.2.3296.9176

info.fr@smithsconnectors.com

Germany

49.991.250.120

info.de@smithsconnectors.com

Italy

39.10.60361

info.it@smithsconnectors.com

United Kingdom

44.208.236.2400

info.uk@smithsconnectors.com

ASIA

asiainfo@smithsconnectors.com

Shanghai, China

86.21.3318.4650

Suzhou, China

86.512.6273.1188

Singapore

65.6846.1655

visit us at | smithsconnectors.com |     