

**MICRODOT Microminiature D Connectors Introduction**

**Product Facts**

- Designed for both military and commercial applications
- Low engaging force is achieved by the manner in which Twist Pin Contacts are designed
- The metal shell and plastic shell are available with solder cup and solid or stranded wire terminations
- Mating force maximum is 10 oz. [2.78N] times the number of contacts
- Durability — No known mechanical or electrical issues detrimental to the function of the connectors after 500 cycles of mating and unmating
- Current Rating — 3 amps max per contact

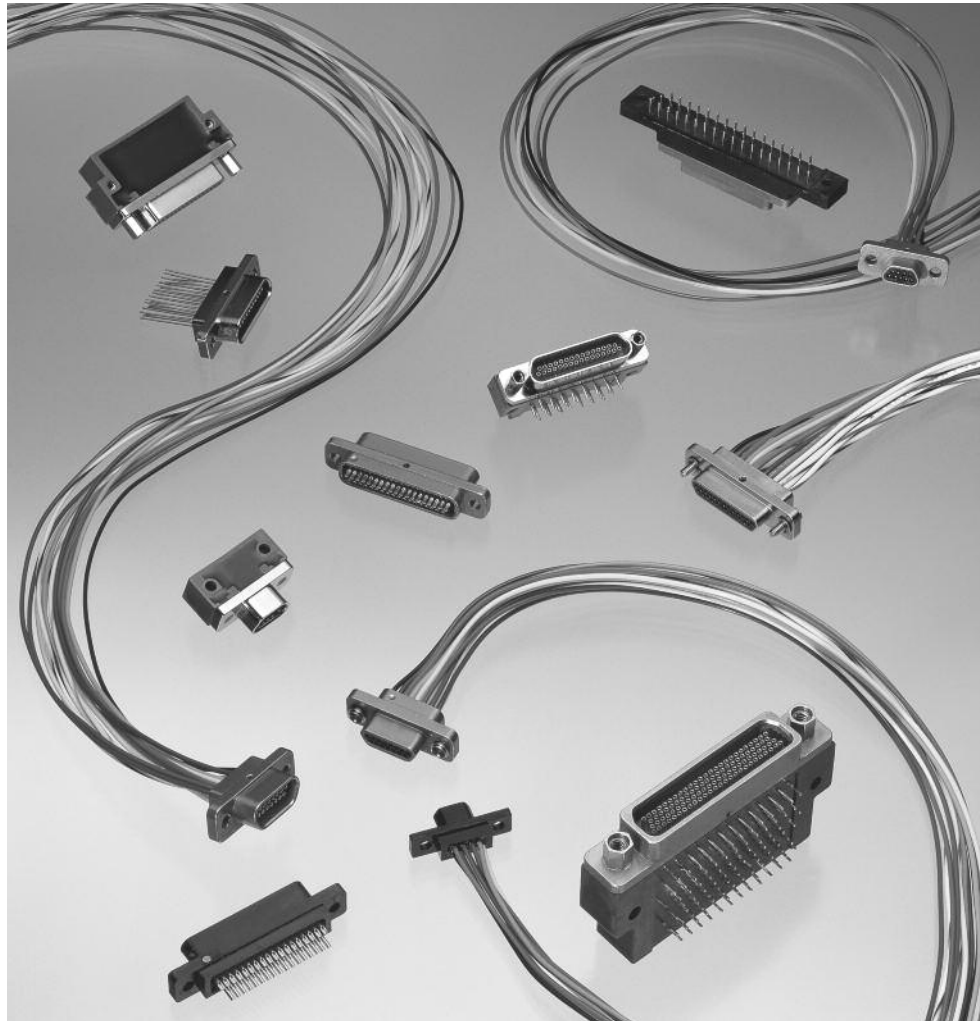

MICRODOT Connectors MCK and MCD High Density Microminiature “D” Connectors described in this catalog comprise a complete connector system, which is adaptable to a numerous variety of form factors. Low engaging force is achieved by the manner in which the twist pin contacts are designed. By constructing the male contact as a breathing helical spring, electrical contact is achieved at many points around the periphery of the pin bundle rather than at a few discrete

points, as in conventional pin designs. Normal twist pin engagement force is 6 oz. [1.67N] typically and 8 oz. [2.22N] maximum. The low force twist pins exhibit an engaging force of 4 oz. [1.11N] typically and 5 oz. [1.39N] maximum.

The MCK and MCD Series of connectors featured in this catalog are designed to meet the applicable requirements of MIL-DTL-83513, for intermateability, interchangeability, and performance. Designed for both military and commercial applications, the MCK’s

and MCD’s are especially well suited for use in miniaturized airborne and space electronics, computers, and test equipment. The metal shell MCK’s and plastic shell MCD’s are available with solder cup, and solid or stranded wire terminations. MCK transition blocks are standard for printed circuit board mounting. Custom termination configurations for both MCK and MCD can be accommodated. Micro D’s are also supplied in wired harness assemblies.

**MICRODOT MCK/MCD/MCDM Series Metal and Plastic Shell Connectors**

**Technical and Performance Data**

(Applicable to MCK, MCD and MCDM unless otherwise noted)

**Electrical**

**Contacts** — Pin 24 AWG twist pin, Socket 24 AWG precision machined barrel or Stamped and Formed 24 AWG Pin and Socket. Wire Range 24 AWG to 30 AWG solid and stranded.

**Contact Resistance** — (voltage drop) 25 millivolts max. at 3 amps, 77°± 7.4°F [25°± 3° C].

**Current Rating** — 3 amps max. per contact.

**Dielectric Withstanding Voltage** — Volts RMS 60 Hz at room ambient. At sea level 600V  
At 70,000 ft. [21,336 m] 150V

**Insulation Resistance** — 5,000 megohms min. (@ 500 VDC) at ambient room temperature.

**Magnetic Permeability** — 2 mu max.

**Mechanical**

**Contact Spacing** — .050 [1.27mm] centers.

**Contact Engagement & Separation** — Standard contact engaging force is 6.0 oz. [1.67N] (8.0 oz. [2.22N] max.). Separation force is 0.5 [.14N] oz. min.

**Mating Force Maximum** — Calculated as 10 oz. times the number of contacts.

**Environmental**

**Temperature Range** — -67°F to 257°F [-55° C to +125°C] for MCK/MCD, -67°F to 302°F [-55°C to +150°C] for MCDM.

**Vibration** — No discontinuity in excess of 1 μ second when tested in accordance with EIA-364-28, test condition IV.

**Solderability** — Connectors shall pass the test requirements of MIL-STD-202, Method 208

**Shock** — No discontinuity in excess of 1 μ second when tested in accordance with EIA-364-27, test condition E.

**Durability** — No mechanical or electrical defects detrimental to the function of the connectors after 500 cycles of mating and unmating.

**Humidity** — After exposure to humidity as specified EIA-364-31, Method II, IR shall be 1 megohm minimum following step 7a of EIA-364-31 section 4.3.6.1 and 1000 megohms minimum after 24 hours of conditioning per EIA-364-31.

**Salt Spray** — Connectors shall meet the performance requirements of contact resistance, mating and unmating forces, and contact retention after being subjected to the 48 hour 5% solution salt spray test per EIA-364-26, Condition B.

**Fluid Immersion** — Unmated connectors after being fully immersed in one of the following fluids, for the prescribed time, will mate at a force of 10 oz. [2.78N] times the number of contacts or less: Perchloroethylene, 2 hours;

Lubricating oil per MIL-L-23699, 20 hours.

**Insert Retention** — Inserts will withstand a 50 lb. [34N/cm<sup>2</sup>] per square inch load in either direction.

**Crimp Termination Tensile Strength** — (Unassembled contacts with crimped stranded wire terminations) Wires will not pull out of contacts when the following axial loads are applied: 24 AWG, 5 lbs. [22.24N]; 26 AWG, 4 lbs. [17.79N]; 28 AWG, 3 lbs. [13.34N]

**Outgassing** — When tested in accordance with SP-R-0022, Total Mass Loss (TML) shall be less than 1.0% and Volatile Condensable Material (VCM) shall be less than 0.1% of the original specimen.

**Materials and Finishes**

**Contacts** — Copper alloy plated with .000050 [.00127] gold over copper flash per MIL-G-45204 Type II.

**Hardware** — see pages 5-61 and 5-62.

**MCK-Metal Shell** —

Insulator — Liquid crystal polymer (LCP) per ASTM D5138, or Polyphenylene sulfide per ASTM D4067 or MIL-M-24519

Interfacial Seal — Fluorosilicone Rubber per MIL-R-25988 (socket side only)

Body Shell — Aluminum alloy-high grade plated

Cadmium per QQ-P-416

Nickel, electroless per AMS 2404

**Transition Block Shell** —

Liquid crystal polymer (LCP) per ASTM D5138, or Polyphenylene sulfide per ASTM D4067 or MIL-M-24519

Potting Material — Epoxy, Black

**MCD-Plastic Shell** —

Insulator/Body — Polyester, glass filled per MIL-M-24519, Liquid crystal polymer (LCP) per ASTM D5138, or Polyphenylene sulfide per ASTM D4067 or MIL-M-24519

**Wire Terminations** —

Solid copper per QQ-W-343 gold plated per MIL-DTL-45204

Stranded TEFLON insulated per MIL-W-16878

Stranded TEFLON insulated per MIL-W-22759/11, /33

Solid copper per QQ-W-343, solder dipped (Transition block)

**MCDM-Metal Shell** —

Insulator — Diallyl Phthalate per MIL-M-14, Type SDG-F

Body Shell — Aluminum alloy—high grade, nickel plated

**Twist Pin, Pin and Socket Contacts**

The contact spring member normally found in socket contacts has been eliminated by creating a breathing helical spring principle on the pin contact — smaller, more durable contacts can be manufactured economically.



Wire range 24-36 AWG solid & stranded.

MIL-DTL-83513 — Only the descriptive legend in bold italic is applicable to current MIL-DTL-83513 configurations; MIL-DTL-83513/1 through /4 — MCKS metal shell; MIL-DTL-83513/6 through /9 — MCD plastic shell.

In addition, MIL-DTL-83513 solid copper wire termination is specified 25 AWG, 0.5; and 1.0 [25.4] lengths only and stranded insulated wire termination is specified 26 AWG, 18.0 [457.2] and 36.0 [914.4] lead lengths only. Hardware for MIL-DTL-83513 configurations is specified separately by the M83513/5-XX designation. M83513/1 through /4 and /6 through /9 specify no hardware (B). Mounting/mating hardware is shown on page 5-61 with the applicable military nomenclature. The MICRODOT catalog part number for a MIL-DTL-83513 configuration may be constructed to include the desired hardware.

See pages 5-78 through 5-82 for M83513/ cross reference.

**MICRODOT How To Specify MCK and MCD Connectors**

**Metal Shell**

Connector Series **MCK** — N1 — B — 37 P 6 A 1 — 18.0

MCK — Twist Pin & Drawn Socket  
MCKS — Stamp & Formed Pin & Socket

Shell Finish  
C1 — Cadmium, Clear  
C2 — Cadmium, Yellow Chromate  
N1 — Nickel, Electroless

Hardware (See Pages 5-79 and 5-80)  
B — No Hardware  
F — Float Bushing  
KM — Jackscrew, Slotted Head, High Profile (9-51)  
HM — Jackscrew, Slotted Head, High Profile (100)  
LM — Jackscrew, Slotted Head, Low Profile (9-51)  
JM — Jackscrew, Slotted Head, Low Profile (100)  
QM — Jackscrew, Allen Head, High Profile (9-51)  
TM — Jackscrew, Allen Head, High Profile (100)  
RM — Jackscrew, Allen Head, Low Profile (9-51)  
NM — Jackscrew, Allen Head, Low Profile (100)  
P — Jackpost Assembly (9-51)  
S — Jackpost Assembly (100)  
X — Lockscrew, Slotted Head  
Y — Lockscrew, Allen Head  
Z — Clip and Key (Clip Mount Only)

Layout  
9, 15, 21, 25, 31, 37, 51, 100  
See contact arrangement

Contact Type  
P — Pin (Plug)  
S — Socket (Receptacle)

S — Solder pots 26 AWG max.  
X — Special, not described by legend.

Lead Length in Inches (Min.)

Insulation Color or Finish  
1 — All white wire 6 — Bare (unfinished)  
2 — All yellow wire 7 — Color coded per MIL-STD-681, System 1  
3 — All gray wire 8 — Special color code  
4 — Gold plated 9 — 10 Solid color repeating per MIL-DTL-83513  
5 — Tin dipped gold plated

Wire Type  
Per MIL-W-16878  
A — Type E, 7 strand  
B — Type ET, 7 strand  
C — Type E, 19 strand  
D — Type ET, 19 strand  
F — 7 strand per MIL-W-22759/11 (28 AWG only)  
G — 19 strand per MIL-C-22759/11 (26 AWG only), 24 AWG  
L — Copper, Solid (25 AWG only)  
Q — Stranded per MIL-W-22759/33 (26 AWG only)

Wire Size  
4 — 24 AWG 5 — 25 AWG 6 — 26 AWG 8 — 28 AWG 0 — 30 AWG

**Plastic Shell**

Connector Series **MCD** — R3 — B — 37 P 6 A 1 — 18.0

Insulator Type/Material  
G2 — Clip Mount, polyester, natural  
G3 — Screw Mount, polyester, natural, .093 Fig.  
R2 — Clip Mount, Ryton  
R3 — Screw Mount, Liquid Crystal Polymer or Polyphenylene Sulfide

Hardware (See Pages 5-79 and 5-80)  
B — No Hardware  
F — Float Bushing  
KM — Jackscrew, Slotted Head, High Profile  
LM — Jackscrew, Slotted Head, Low Profile  
QM — Jackscrew, Allen Head, High Profile  
RM — Jackscrew, Allen Head, Low Profile  
P — Jackpost Assembly  
X — Lockscrew, Slotted Head  
Y — Lockscrew, Allen Head  
Z — Clip and Key (Clip Mount Only)

Layout  
9, 15, 21, 25, 31, 37, 51  
See contact arrangement

Contact Type  
P — Pin (Plug)  
S — Socket (Receptacle)

S — Solder pots 26 AWG max.  
X — Special — Does not fit description below.

Lead Length in Inches (Min.)

Insulation Color or Finish  
1 — All white wire 6 — Bare (unfinished)  
2 — All yellow wire 7 — Color coded per MIL-STD-681, System 1  
3 — All gray wire 8 — Special color code  
4 — Gold plated 9 — 10 Solid color repeating per MIL-DTL-83513  
5 — Tin dipped gold plated

Wire Type  
Per MIL-W-16878  
A — Type E, 7 strand  
B — Type ET, 7 strand  
C — Type E, 19 strand  
D — Type ET, 19 strand  
F — 7 strand per MIL-W-22759/11 (28 AWG only)  
G — 19 strand per MIL-C-22759/11 (26 AWG only), 24 AWG  
L — Copper, Solid (25 AWG only)  
Q — Stranded per MIL-W-22759/33 (26 AWG only)

Wire Size  
4 — 24 AWG 5 — 25 AWG 6 — 26 AWG 8 — 28 AWG 0 — 30 AWG

**Note: Items in bold italic are qualified to MIL-DTL-83513.**

**MICRODOT Contact Arrangements**

**Face View of Pin Insert  
(Socket Side is Mirror Image)**

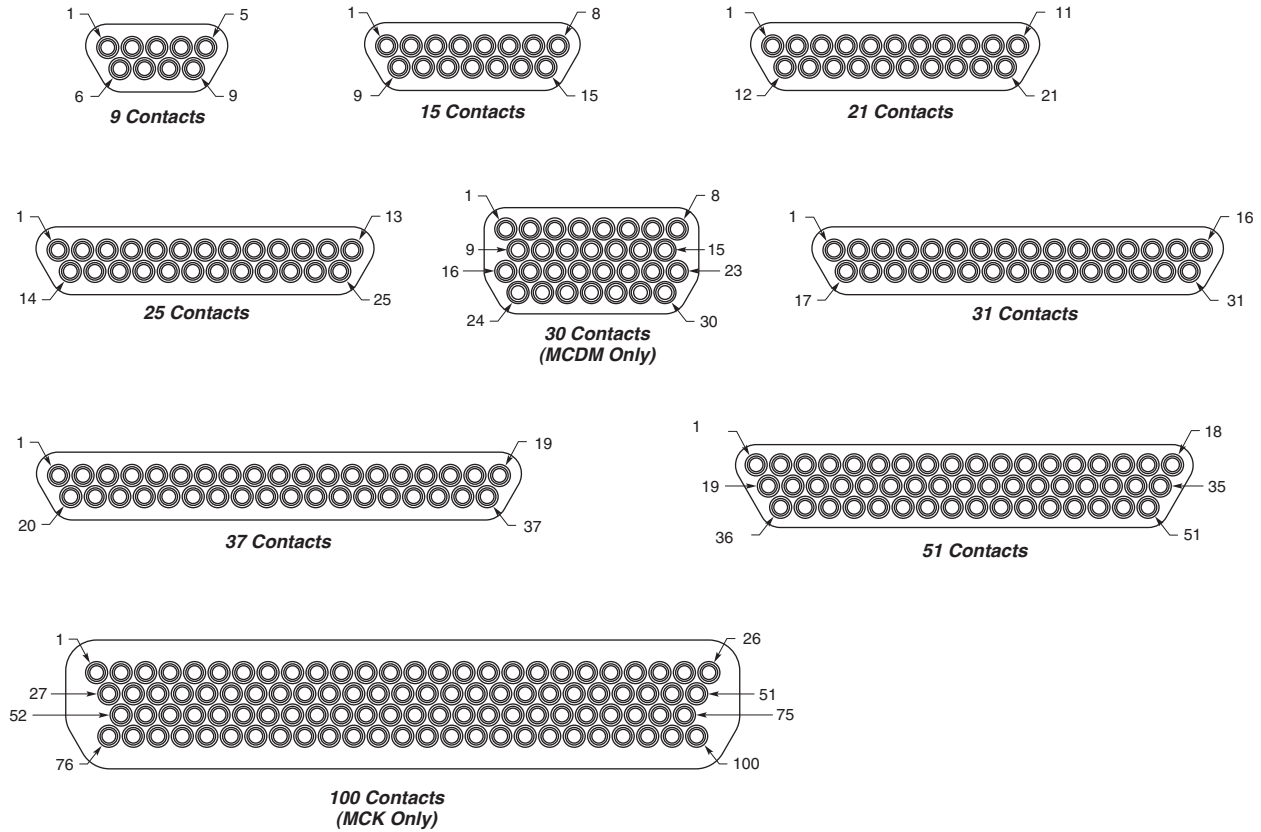

**Note:** MCK metal shells are not designed to intermate or interchange with MCD plastic shells. If metal/plastic intermating is desired, use MCDM Series Metal Shell on pages 5-72 and 5-73 with MCD Series Plastic Shell on page 5-58.

**MICRODOT MCK Series Metal Shell Connectors**

**Dimensions per MIL-DTL-83513**



**Plug  
(Pin side)**

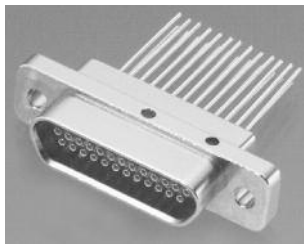

**Receptacle  
(Socket side)**

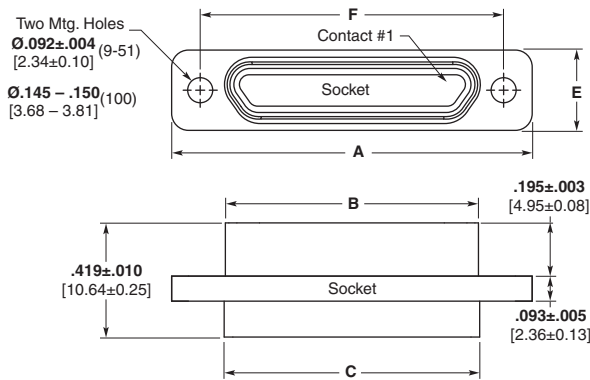
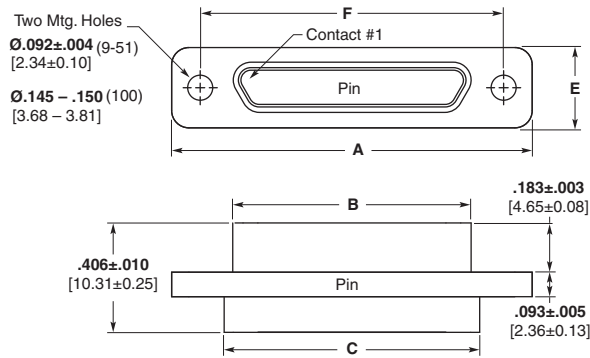

Part Number	A $\pm .010$ [.254]	B Max.	C $+0.010$ [.254] $-0.018$ [.457]	D Max	E $\pm 0.010$ [.254]	F $\pm 0.005$ [.127]
MCK**- 9P***	.775 19.68	.3338 8.48	.390 9.91	.270 6.86	.298 7.57	.565 14.35
MCK**- 9S***	.775 19.68	.4018 10.21	.390 9.91	.270 6.86	.298 7.57	.565 14.35
MCK**- 15P***	.925 23.50	.4838 12.29	.540 13.72	.270 6.86	.298 7.57	.715 18.16
MCK**- 15S***	.925 23.50	.5518 14.02	.540 13.72	.270 6.86	.298 7.57	.715 18.16
MCK**- 21P***	1.075 27.30	.6338 16.10	.690 17.53	.270 6.86	.298 7.57	.865 21.97
MCK**- 21S***	1.075 27.30	.7018 18.05	.690 17.53	.270 6.86	.298 7.57	.865 21.97
MCK**- 25P***	1.175 29.84	.7338 18.64	.790 20.07	.270 6.86	.298 7.57	.965 24.51
MCK**- 25S***	1.175 29.84	.8018 20.37	.790 20.07	.270 6.86	.298 7.57	.965 24.51
MCK**- 31P***	1.325 33.66	.8838 22.45	.940 23.88	.270 6.86	.298 7.57	1.115 28.32
MCK**- 31S***	1.325 33.66	.9518 24.18	.940 23.88	.270 6.86	.298 7.57	1.115 28.32
MCK**- 37P***	1.475 37.46	1.0338 26.26	1.090 27.69	.270 6.86	.298 7.57	1.265 32.13
MCK**- 37S***	1.475 37.46	1.1018 27.99	1.090 27.69	.270 6.86	.298 7.57	1.265 32.13
MCK**- 51P***	1.425 36.20	.9838 24.99	1.040 26.42	.310 7.87	.341 8.66	1.215 30.86
MCK**- 51S***	1.425 36.20	1.0518 26.72	1.040 26.42	.310 7.87	.341 8.66	1.215 30.86
MCK**- 100P***	2.160 54.86	1.3838 35.15	1.432 36.37	.360 9.15	.384 9.75	1.800 45.71
MCK**- 100S***	2.160 54.86	1.508 38.30	1.432 36.37	.360 9.15	.384 9.75	1.800 45.71

P = Pin, S = Socket

**MICRODOT MCK Series Metal Shell Connectors Panel Mounting — Cutout Dimensions**

**Panel Mounting Dimensions — MCK**

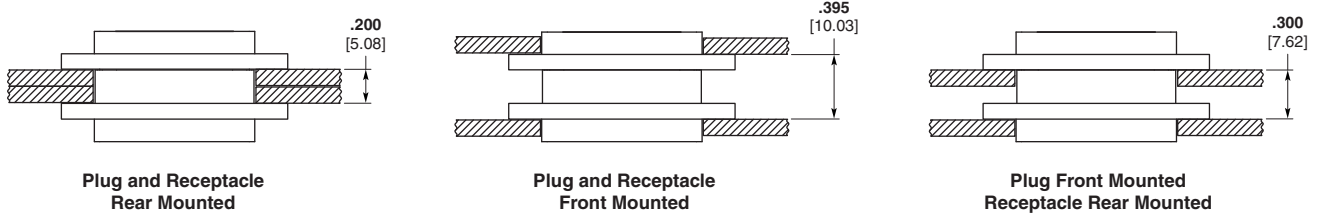

**Panel Cutout Dimensions — MCK**

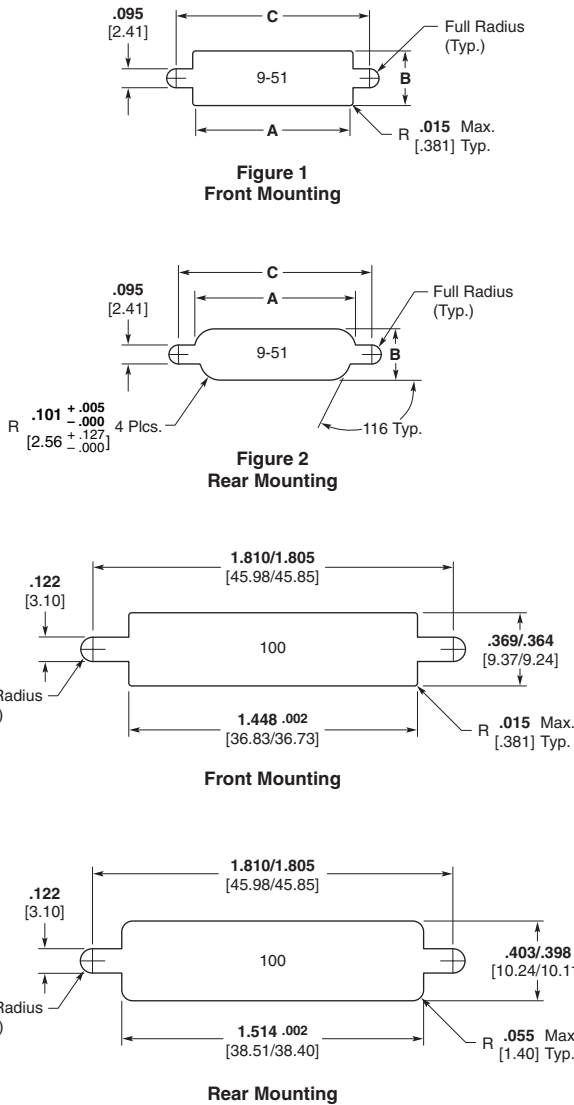

Number of Contacts	Fig.	A + .004 [.102] - .000 [.000]	B + .004 [.102] - .000 [.000]	C + .005 [.127] - .000 [.000]
9	1	.404 10.26	.274 6.96	.570 14.48
	2	.406 10.31	.257 6.53	.570 14.48
15	1	.554 14.07	.274 6.96	.720 18.29
	2	.556 14.12	.257 6.53	.720 18.29
21	1	.704 17.88	.274 6.96	.870 22.10
	2	.706 17.93	.257 6.53	.870 22.10
25	1	.804 20.42	.274 6.96	.970 24.64
	2	.806 20.47	.257 6.53	.970 24.64
31	1	.954 24.23	.274 6.96	1.120 28.45
	2	.956 24.28	.257 6.53	1.120 28.45
37	1	1.104 28.04	.274 6.96	1.270 32.26
	2	1.106 28.09	.257 6.53	1.270 32.26
51	1	1.054 26.77	.314 7.98	1.220 30.99
	2	1.056 26.82	.300 7.62	1.220 30.99

**MICRODOT MCD Series Plastic Shell Connectors**

**Screw Mount Dimensions Per MIL-DTL-83513**

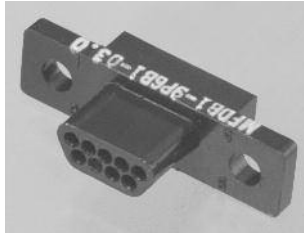

**Plug  
(Pin side)**

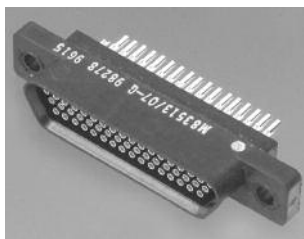

**Receptacle  
(Socket side)**

Liquid Crystal Polymer or Polyphenylene Sulfide — MCDR3\* per MIL-DTL-83513

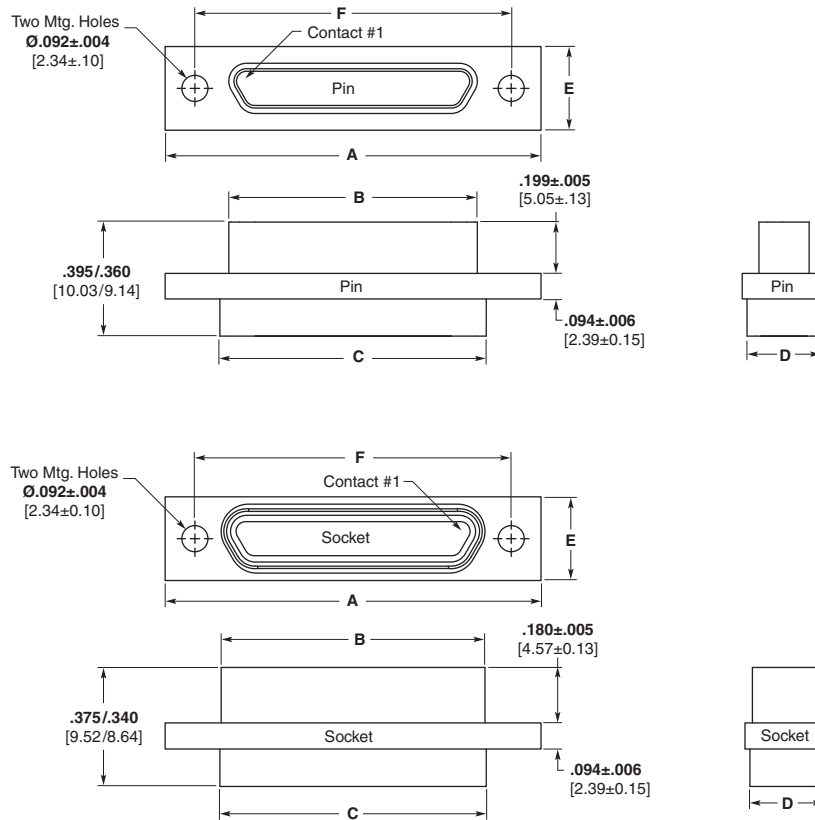

**Note:** MCD Plastic Screw Mount Series is intermateable with MCDM Metal Series Connectors (Pages 5-72 and 5-73).

Part Number	A ± .010 [.254]	B Max.	C +.010 [.254] -.018 [.457]	D Max	E ±.010 [.254]	F ± .005 [.127]	Avg. Weight lbs. ± 5% [grams]
MCD**- 9P***	.778 19.76	.2918 7.412	.398 10.11	.173 4.39	.208 5.28	.565 14.35	.0017 0.77
MCD**- 9S***	.778 19.76	.3798 9.647	.398 10.11	.173 4.39	.208 5.28	.565 14.35	.0016 0.72
MCD**- 15P***	.928 23.57	.4418 11.222	.548 13.92	.173 4.39	.208 5.28	.715 18.16	.0024 1.08
MCD**- 15S***	.928 23.57	.5298 13.457	.548 13.92	.173 4.39	.208 5.28	.715 18.16	.0023 1.04
MCD**- 21P***	1.078 27.38	.5918 15.032	.698 17.73	.173 4.39	.208 5.28	.865 21.97	.0035 1.59
MCD**- 21S***	1.078 27.38	.6798 17.267	.698 17.73	.173 4.39	.208 5.28	.865 21.97	.0034 1.54
MCD**- 25P***	1.178 29.92	.6918 17.572	.798 20.27	.173 4.39	.208 5.28	.965 24.51	.0042 1.90
MCD**- 25S***	1.178 29.92	.7798 19.807	.798 20.27	.173 4.39	.208 5.28	.965 24.51	.0037 1.67
MCD**- 31P***	1.328 33.73	.8418 21.382	.948 24.08	.173 4.39	.208 5.28	1.115 28.32	.0053 2.40
MCD**- 31S***	1.328 33.73	.9298 23.617	.948 24.08	.173 4.39	.208 5.28	1.115 28.32	.0048 2.17
MCD**- 37P***	1.478 37.54	.9918 25.192	1.098 27.89	.173 4.39	.208 5.28	1.265 32.13	.0057 2.58
MCD**- 37S***	1.478 37.54	1.0798 27.427	1.098 27.89	.173 4.39	.208 5.28	1.265 32.13	.0051 2.31
MCD**- 51P***	1.428 36.27	.9418 23.922	1.048 26.62	.220 5.59	.250 6.35	1.215 30.86	.0072 3.26
MCD**- 51S***	1.428 36.27	1.0298 26.157	1.048 26.62	.220 5.59	.250 6.35	1.215 30.86	.0063 2.85

P = Pin, S = Socket

**Note:** Weight given is with .500 [12.7] uninsulated, solid, 24 AWG gold plated copper pigtailed.

\*See "How to Specify" for description, on page 5-54.

**MICRODOT MCD Series Plastic Shell Connectors** (Continued)

**Clip Mount — MCD**



**Plug  
(Pin side)**

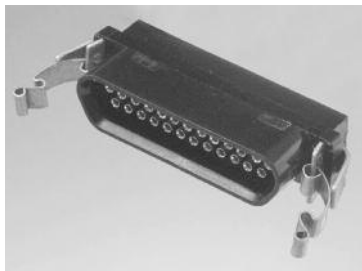

**Receptacle  
(Socket side)**

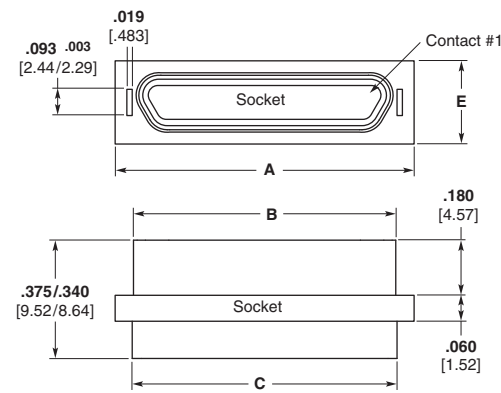
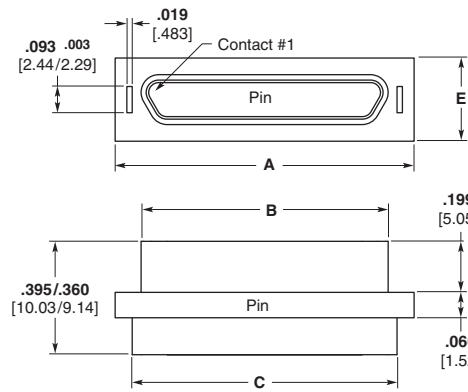

**Note:** Clip Mount not covered by current issue of MIL-DTL-83513.

Part Number	A ±.005 [.127]	B Max.	C ±.010 [.254]	D ±.010 [.254]	E ±.005 [.127]	Avg. Weight lbs. ± 5% [grams]
MCD**- 9P***	.506 12.85	.2918 74.12	.398 10.11	.165 4.19	.208 5.28	.0017 0.77
MCD**- 9S***	.506 12.85	.3798 96.47	.398 10.11	.165 4.19	.208 5.28	.0016 0.72
MCD**- 15P***	.656 16.66	.4418 112.22	.548 13.92	.165 4.19	.208 5.28	.0024 1.08
MCD**- 15S***	.656 16.66	.5298 134.57	.548 13.92	.165 4.19	.208 5.28	.0023 1.04
MCD**- 21P***	.806 20.47	.5918 150.32	.698 17.73	.165 4.19	.208 5.28	.0035 1.59
MCD**- 21S***	.806 20.47	.6798 172.67	.698 17.73	.165 4.19	.208 5.28	.0034 1.54
MCD**- 25P***	.906 23.01	.6918 175.72	.798 20.27	.165 4.19	.208 5.28	.0042 1.90
MCD**- 25S***	.906 23.01	.7798 198.07	.798 20.27	.165 4.19	.208 5.28	.0037 1.67
MCD**- 31P***	1.056 26.82	.8418 213.82	.948 24.08	.165 4.19	.208 5.28	.0053 2.40
MCD**- 31S***	1.056 26.82	.9298 236.17	.948 24.08	.165 4.19	.208 5.28	.0048 2.17
MCD**- 37P***	1.206 30.63	.9918 251.92	1.098 27.89	.165 4.19	.208 5.28	.0057 2.58
MCD**- 37S***	1.206 30.63	1.0798 274.27	1.098 27.89	.165 4.19	.208 5.28	.0051 2.31
MCD**- 51P***	1.156 29.36	.9418 239.22	1.048 26.62	.208 5.28	.250 6.35	.0072 3.26
MCD**- 51S***	1.156 29.36	1.0298 261.57	1.048 26.62	.208 5.28	.250 6.35	.0063 2.85

P = Pin, S = Socket

**Note:** Weight given is with .500 [12.7] uninsulated, solid, 24 AWG gold plated copper pigtails.

\*See "How to Specify" for description, on page 5-54.



**MICRODOT MCD Series Plastic Shell Connectors Panel Mounting — Cutout Dimensions**

**Panel Mounting Dimensions — MCD**

**Clip Mount**

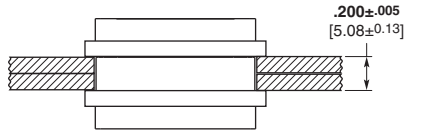

Plug and Receptacle Rear Mounted

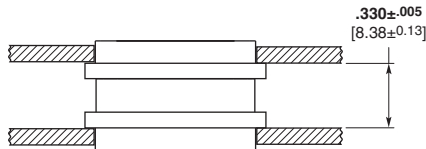

Plug and Receptacle Front Mounted

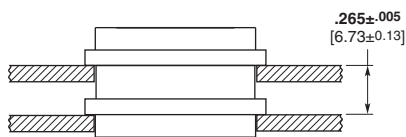

Plug Front Mounted Receptacle Rear Mounted

**Screw Mount**

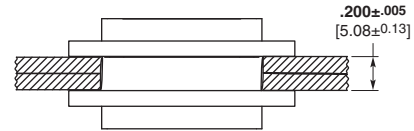

Plug and Receptacle Rear Mounted

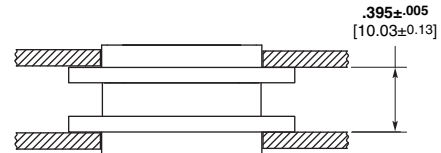

Plug and Receptacle Front Mounted

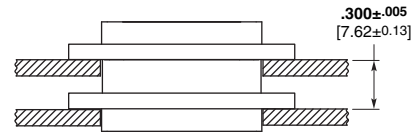

Plug Front Mounted Receptacle Rear Mounted

**Panel Cutout Dimensions — MCD**

**Clip Mounting**

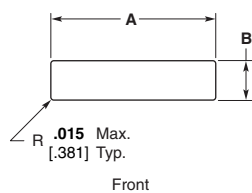

Figure 1

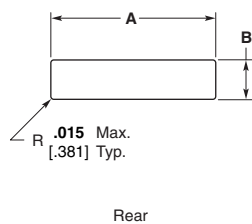

Figure 3

**Screw Mounting**

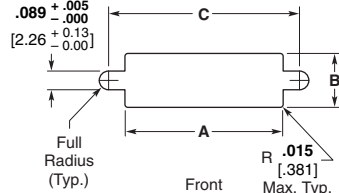

Figure 2

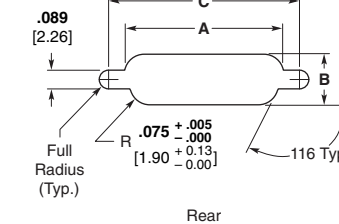

Figure 4

Notes: Front mounting preferred.

Number of Contacts	Fig.	A		B		C	
		+ .004 [.102]	-.000 [.000]	+ .004 [.102]	-.000 [.000]	+ .005 [.127]	-.000 [.000]
9	1	.438	[11.13]	.177	[4.50]	—	—
	2	.412	[10.46]	.177	[4.50]	.570	[14.48]
	3	.438	[11.13]	.222	[5.64]	—	—
	4	.384	[9.75]	.222	[5.64]	.570	[14.48]
15	1	.588	[14.93]	.177	[4.50]	—	—
	2	.562	[14.27]	.177	[4.50]	.720	[18.29]
	3	.588	[14.93]	.222	[5.64]	—	—
	4	.534	[13.56]	.222	[5.64]	.720	[18.29]
21	1	.738	[18.75]	.177	[4.50]	—	—
	2	.712	[18.08]	.177	[4.50]	.870	[22.10]
	3	.738	[18.75]	.222	[5.64]	—	—
	4	.684	[17.37]	.222	[5.64]	.870	[22.10]
25	1	.838	[21.29]	.177	[4.50]	—	—
	2	.812	[20.62]	.177	[4.50]	.970	[24.64]
	3	.838	[21.29]	.222	[5.64]	—	—
	4	.784	[19.91]	.222	[5.64]	.970	[24.64]
31	1	.988	[25.10]	.177	[4.50]	—	—
	2	.962	[24.43]	.177	[4.50]	1.120	[28.45]
	3	.988	[25.10]	.222	[5.64]	—	—
	4	.934	[23.72]	.222	[5.64]	1.120	[28.45]
37	1	1.138	[28.91]	.177	[4.50]	—	—
	2	1.112	[28.24]	.177	[4.50]	1.270	[32.26]
	3	1.138	[28.91]	.222	[5.64]	—	—
	4	1.084	[27.53]	.222	[5.64]	1.270	[32.26]
51	1	1.088	[27.64]	.224	[5.69]	—	—
	2	1.062	[26.97]	.224	[5.69]	1.220	[30.99]
	3	1.088	[27.64]	.264	[6.71]	—	—
	4	1.034	[26.26]	.264	[6.71]	1.220	[30.99]

**MICRODOT Mounting and Coupling Hardware**

**For Screw Mount MCK, MCKS, MCD and MCDM**

**9-51 Contacts Slot Head**

(KM)

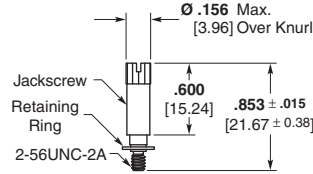

**Part Number 5-1532137-8**  
**Jackscrew Assembly**  
**High Profile**  
**M83513/5-06**  
**(KM) S96-0002-0084**

(LM)

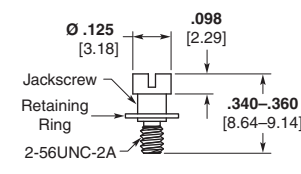

**Part Number 5-1532137-7**  
**Jackscrew Assembly**  
**Low Profile**  
**M83513/5-05**  
**(LM) S96-0002-0085**

(P)

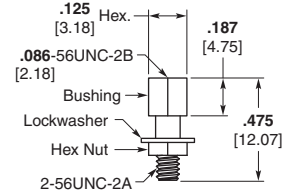

**Part Number 5-1532137-9**  
**Jackpost Assembly**  
**(P) S96-0002-0009**  
**M83513/5-07**

P mates with KM, LM, QM and RM Jackscrew Assemblies.

**9-51 Contacts 1/16" Allen Head**

(QM)

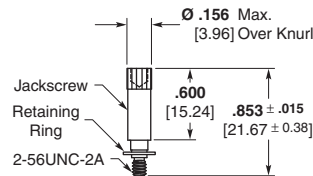

**Part Number 5-1532137-6**  
**Jackscrew Assembly**  
**High Profile**  
**M83513/5-03**  
**(QM) S96-0002-0086**

(RM)

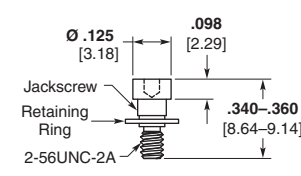

**Part Number 5-1532137-5**  
**Jackscrew Assembly**  
**Low Profile**  
**M83513/5-02**  
**(RM) S96-0002-0087**

**Notes:**

1. Jackpost Assemblies will accommodate .094 [2.39] max. thickness panel.
2. Letter(s) in parentheses is to assist in ordering hardware with the connector (See "How To Specify" page 5-54).
3. **Items in bold italic are qualified to MIL-DTL-83513.**
4. Mounting torque values and mating torque values are per MIL-DTL-83513/5.

**100 Contacts Slot Head**

(HM)

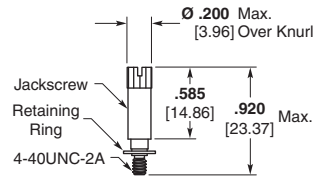

**Part Number 6-1532137-3**  
**Jackscrew Assembly**  
**High Profile**  
**M83513/5-16**  
**(HM) S96-0002-0088**

(JM)

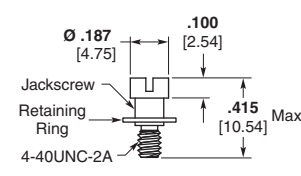

**Part Number 6-1532137-2**  
**Jackscrew Assembly**  
**Low Profile**  
**M83513/5-15**  
**(JM) S96-0002-0089**

**100 Contacts 1/16" Allen Head**

(TM)

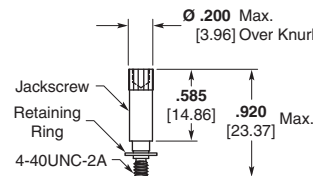

**Part Number 6-1532137-1**  
**Jackscrew Assembly**  
**High Profile**  
**M83513/5-13**  
**(TM) S96-0002-0090**

(NM)

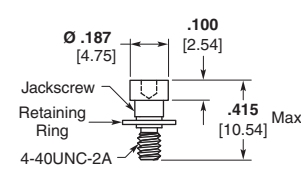

**Part Number 6-1532137-0**  
**Jackscrew Assembly**  
**Low Profile**  
**M83513/5-12**  
**(NM) S96-0002-0091**

(S)

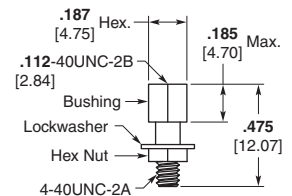

**Part Number 6-1532137-4**  
**Jackpost Assembly**  
**(S) S96-0002-0060**  
**M83513/5-17**

S mates with HM, JM, TM and NM Jackscrew Assemblies.

**MICRODOT Mounting and Coupling Hardware** (Continued)

**For Screw Mount MCK, MCD and MCDM** (Continued)

**Slot Head**  
(X)

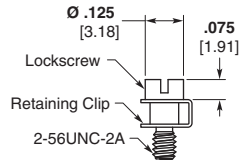

**Part Number 4-1532137-3**  
**Lockscrew Assembly**  
**096-0002-0008**

**1/16" Allen Head**  
(Y)

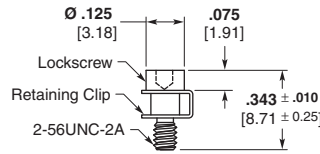

**Part Number 1495164-1**  
**Lockscrew Assembly**  
**096-0002-0013**

**For Clip Mount — MCD**

(Z)

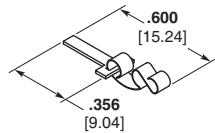

**Part Number 1466018-1**  
**Mounting Key and Clip**  
**P/N 096-0001-0000**  
**(2 Required)**

**For Float Mount — MCK, MCD and MCDM**

(F)

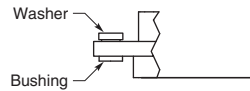

**Float Mount Bushing**  
**(Factory Installed)**

**Notes:**

1. Jackpost Assemblies will accommodate .094 [2.39] max. thickness panel.
2. Letter(s) in parentheses is to assist in ordering hardware with the connector (See "How To Specify" page 5-54).
3. Hardware ordered separately should be ordered in pairs; i.e. 2 pcs. P/N 096-0002-0013 per connector half.

**MICRODOT MCK Transition Blocks**

**RT1 — Right-Angle Termination Configuration**

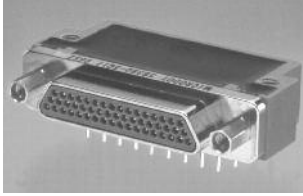

MIL-DTL-83513/10 through /15 configurations. 90° — Narrow Profile termination configurations. See pages 5-78 to 5-82 for M83513 cross references.

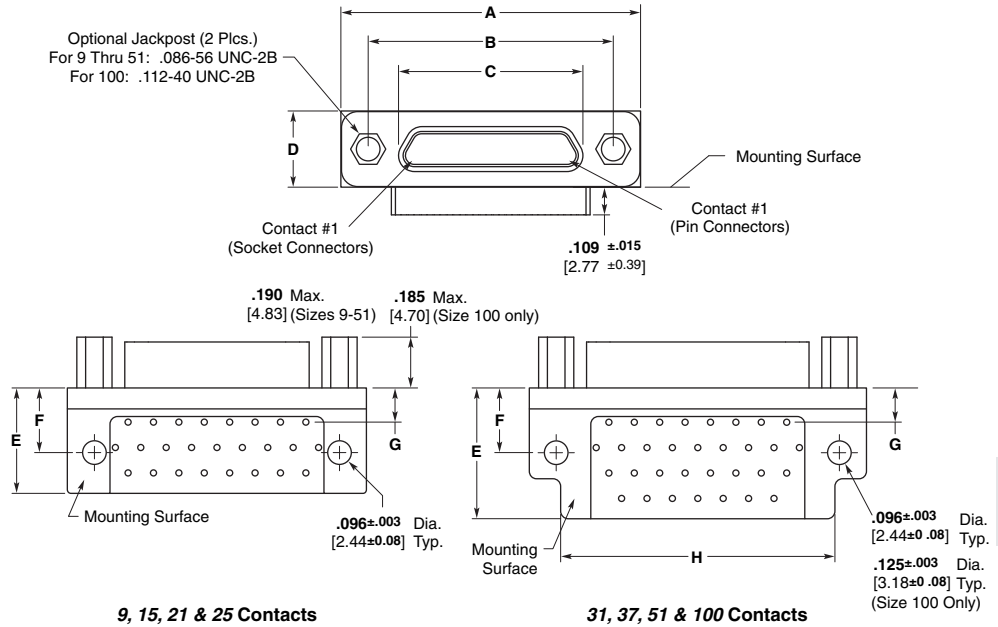

**How To Specify**

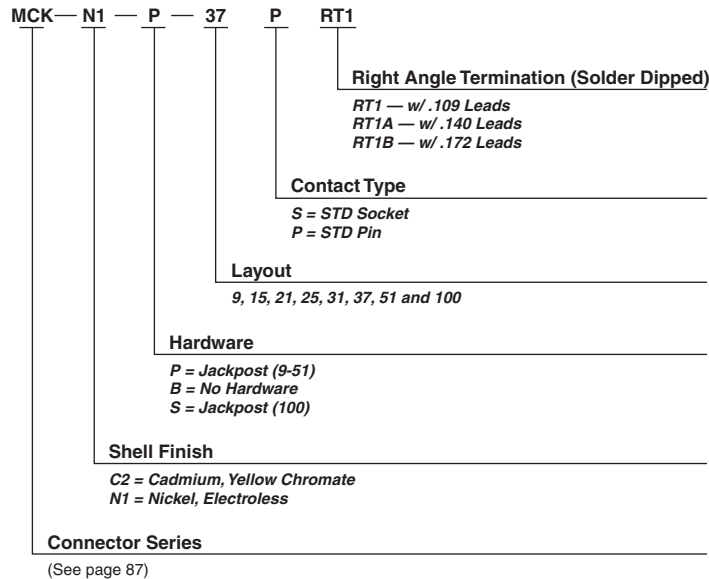

**Notes:**

1. For terminal identification see page 5-65.
2. Grid pattern for all configurations is .100 x .100 [2.54 x 2.54].
3. Lead lengths shown are for RT1.
4. **Items in bold italic are qualified to MIL-DTL-83513.**

**MICRODOT MCK Transition Blocks** (Continued)

**RT1 — Right-Angle Termination Configuration**

(Continued)

Part Number	A Max.	B ± 005 [.127]	C Max.	D Max.	E Max.	F +.010 [.254]	G +.010 [.254]	H Max.
<i>MCK-**-*- 9PRT1</i>	<i>.787</i> 19.99	<i>.565</i> 14.35	<i>.3338</i> 8.48	<i>.308</i> 7.83	<i>.425</i> 10.80	<i>.250</i> 6.35	<i>.230</i> 5.84	—
<i>MCK-**-*- 9SRT1</i>	<i>.787</i> 19.99	<i>.565</i> 14.35	<i>.4018</i> 10.21	<i>.308</i> 7.83	<i>.425</i> 10.80	<i>.250</i> 6.35	<i>.230</i> 5.84	—
<i>MCK-**-*- 15PRT1</i>	<i>.937</i> 23.80	<i>.715</i> 18.16	<i>.4838</i> 12.29	<i>.308</i> 7.83	<i>.425</i> 10.80	<i>.250</i> 6.35	<i>.130</i> 3.30	—
<i>MCK-**-*- 15SRT1</i>	<i>.937</i> 23.80	<i>.715</i> 18.16	<i>.5518</i> 14.02	<i>.308</i> 7.83	<i>.425</i> 10.80	<i>.250</i> 6.35	<i>.130</i> 3.30	—
<i>MCK-**-*- 21PRT1</i>	<i>1.087</i> 27.61	<i>.865</i> 21.97	<i>.6338</i> 16.10	<i>.308</i> 7.83	<i>.425</i> 10.80	<i>.250</i> 6.35	<i>.130</i> 3.30	—
<i>MCK-**-*- 21SRT1</i>	<i>1.087</i> 27.61	<i>.865</i> 21.97	<i>.7018</i> 17.83	<i>.308</i> 7.83	<i>.425</i> 10.80	<i>.250</i> 6.35	<i>.130</i> 3.30	—
<i>MCK-**-*- 25PRT1</i>	<i>1.187</i> 30.15	<i>.965</i> 24.51	<i>.7338</i> 18.64	<i>.308</i> 7.83	<i>.425</i> 10.80	<i>.250</i> 6.35	<i>.130</i> 3.30	—
<i>MCK-**-*- 25SRT1</i>	<i>1.187</i> 30.15	<i>.965</i> 24.51	<i>.8018</i> 20.37	<i>.308</i> 7.83	<i>.425</i> 10.80	<i>.250</i> 6.35	<i>.130</i> 3.30	—
<i>MCK-**-*- 31PRT1</i>	<i>1.337</i> 33.96	<i>1.115</i> 28.32	<i>.8838</i> 22.45	<i>.308</i> 7.83	<i>.525</i> 13.34	<i>.250</i> 6.35	<i>.130</i> 3.30	<b>1.090</b> 27.69
<i>MCK-**-*- 31SRT1</i>	<i>1.337</i> 33.96	<i>1.115</i> 28.32	<i>.9518</i> 24.18	<i>.308</i> 7.83	<i>.525</i> 13.34	<i>.250</i> 6.35	<i>.130</i> 3.30	<b>1.090</b> 27.69
<i>MCK-**-*- 37PRT1</i>	<i>1.487</i> 37.77	<i>1.265</i> 32.13	<i>1.0338</i> 26.26	<i>.308</i> 7.83	<i>.525</i> 13.34	<i>.250</i> 6.35	<i>.130</i> 3.30	<b>1.190</b> 30.23
<i>MCK-**-*- 37SRT1</i>	<i>1.487</i> 37.77	<i>1.265</i> 32.13	<i>1.1018</i> 27.99	<i>.308</i> 7.83	<i>.525</i> 13.34	<i>.250</i> 6.35	<i>.130</i> 3.30	<b>1.190</b> 30.23
<i>MCK-**-*- 51PRT1</i>	<i>1.435</i> 36.45	<i>1.215</i> 30.86	<i>.9838</i> 24.99	<i>.351</i> 8.92	<i>.660</i> 16.76	<i>.300</i> 7.62	<i>.150</i> 3.81	<b>1.230</b> 31.24
<i>MCK-**-*- 51SRT1</i>	<i>1.435</i> 36.45	<i>1.215</i> 30.86	<i>1.0518</i> 26.72	<i>.351</i> 8.92	<i>.660</i> 16.76	<i>.300</i> 7.62	<i>.150</i> 3.81	<b>1.230</b> 31.24
<i>MCK-**-*- 100PRT1</i>	<i>2.175</i> 55.25	<i>1.800</i> 45.72	<i>1.3838</i> 35.15	<i>.394</i> 10.01	<i>1.010</i> 25.65	<i>.400</i> 10.16	<i>.200</i> 5.08	<b>1.825</b> 46.36
<i>MCK-**-*- 100SRT1</i>	<i>2.175</i> 55.25	<i>1.800</i> 45.72	<i>1.508</i> 38.30	<i>.394</i> 10.01	<i>1.010</i> 25.65	<i>.400</i> 10.16	<i>.200</i> 5.08	<b>1.825</b> 46.36

P = Pin, S = Socket

**Note: Items in bold italic are qualified to MIL-DTL-83513.**

**MICRODOT MCK Transition Blocks** (Continued)

**RT1 — Right-Angle Termination Configuration**

(Continued)

View is of termination side of plug connector. For receptacle, use mirror image. (Except 100 contacts)

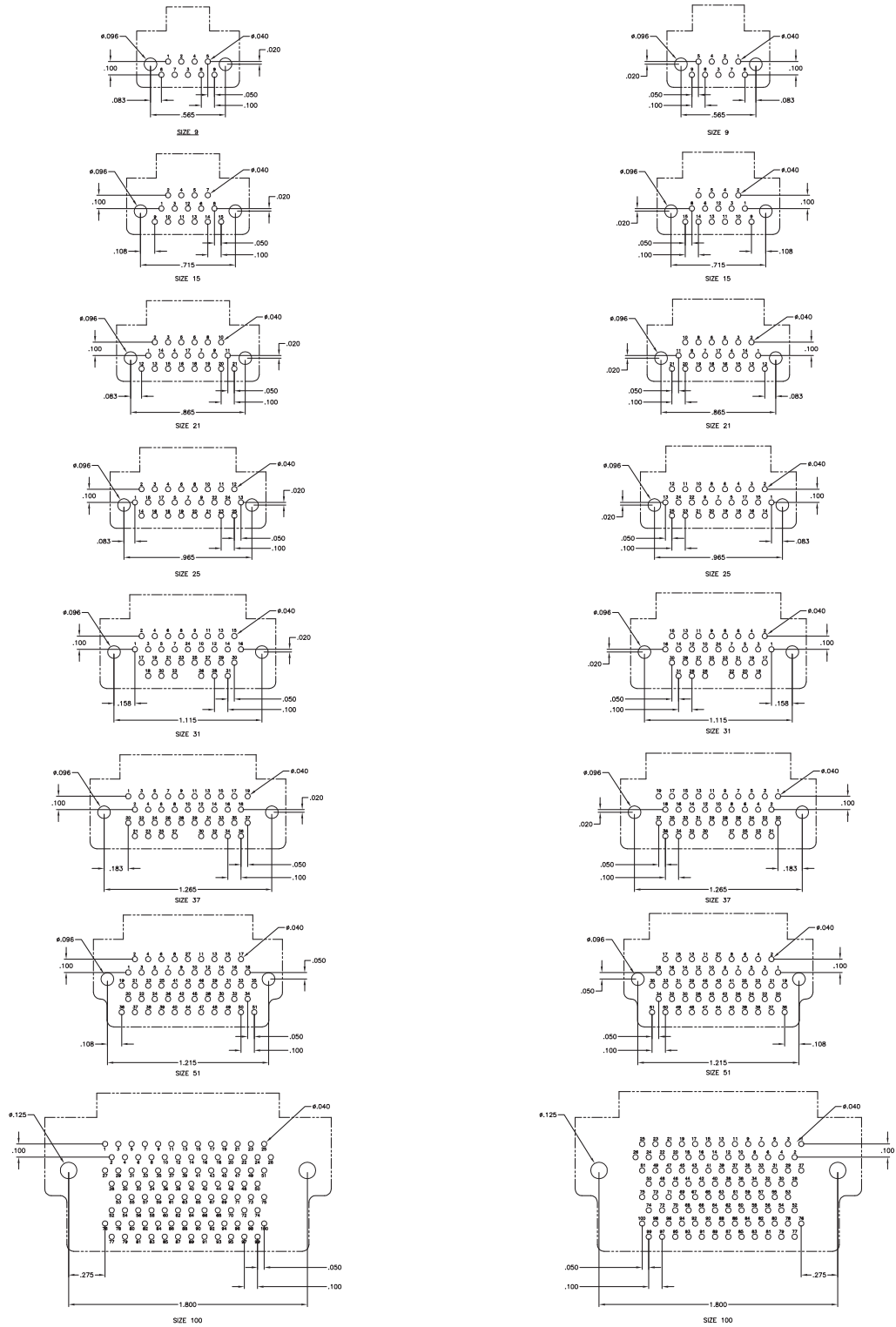

5

Nanominature and Microminiature Connectors

**MICRODOT MCK Transition Blocks** (Continued)

**ST1 — Straight Termination Configuration**

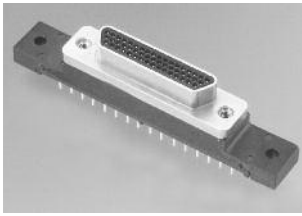

MIL-DTL-83513/22 through /27 configurations. 180° — Narrow Profile termination configurations. See pages 5-78 to 5-82 for M83513 cross references.

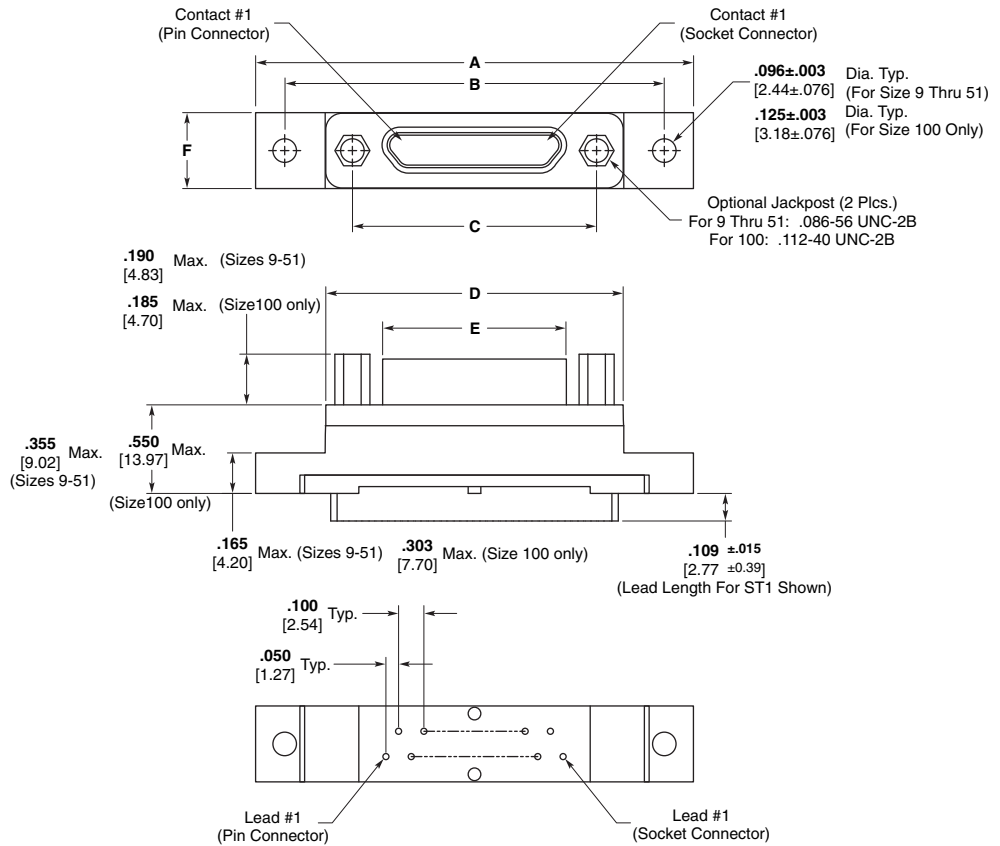

**How To Specify**

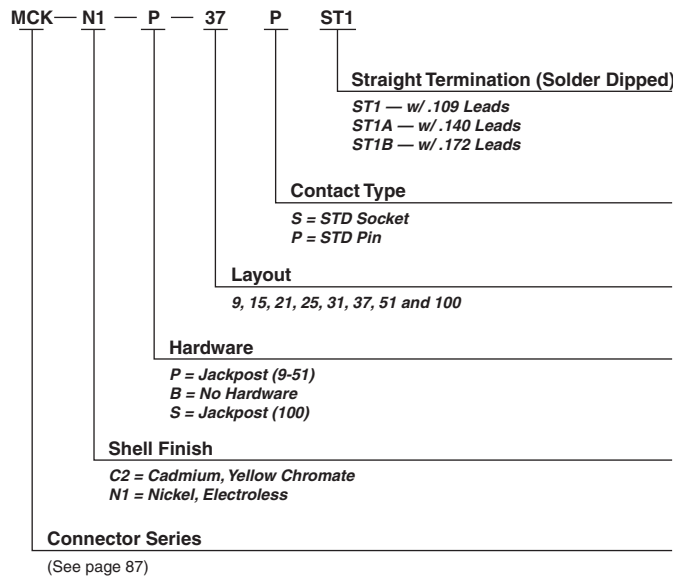

**Notes:**

1. For terminal identification see page 5-81.
2. Grid pattern for all configurations is  $.100 \times .100$  [2.54 x 2.54].
3. Lead lengths shown are for ST1.
4. Items in bold italic are qualified to MIL-DTL-83513.

**MICRODOT MCK Transition Blocks** (Continued)

**ST1 — Straight Termination Configuration** (Continued)

Part Number	A Max.	B ± .007 [.178]	C ± .005 [.127]	D Max.	E Max.	F Max.
<i>MCK-**-*- 9PST1</i>	<b>1.390</b> 35.31	<b>1.150</b> 29.21	<b>.565</b> 14.35	<b>.885</b> 22.48	<b>.3338</b> 8.48	<b>.308</b> 7.83
<i>MCK-**-*- 9SST1</i>	<b>1.390</b> 35.31	<b>1.150</b> 29.21	<b>.565</b> 14.35	<b>.885</b> 22.48	<b>.4018</b> 10.21	<b>.308</b> 7.83
<i>MCK-**-*- 15PST1</i>	<b>1.390</b> 35.31	<b>1.150</b> 29.21	<b>.715</b> 18.16	<b>.945</b> 24.00	<b>.4838</b> 12.29	<b>.308</b> 7.83
<i>MCK-**-*- 15SST1</i>	<b>1.390</b> 35.31	<b>1.150</b> 29.21	<b>.715</b> 18.16	<b>.945</b> 24.00	<b>.5518</b> 14.02	<b>.308</b> 7.83
<i>MCK-**-*- 21PST1</i>	<b>1.690</b> 42.93	<b>1.450</b> 36.83	<b>.865</b> 21.97	<b>1.185</b> 30.10	<b>.6338</b> 16.10	<b>.308</b> 7.83
<i>MCK-**-*- 21SST1</i>	<b>1.690</b> 42.93	<b>1.450</b> 36.83	<b>.865</b> 21.97	<b>1.185</b> 30.10	<b>.7018</b> 17.83	<b>.308</b> 7.83
<i>MCK-**-*- 25PST1</i>	<b>1.740</b> 44.20	<b>1.500</b> 38.10	<b>.965</b> 24.51	<b>1.275</b> 32.39	<b>.7338</b> 18.64	<b>.308</b> 7.83
<i>MCK-**-*- 25SST1</i>	<b>1.740</b> 44.20	<b>1.500</b> 38.10	<b>.965</b> 24.51	<b>1.275</b> 32.39	<b>.8018</b> 20.37	<b>.308</b> 7.83
<i>MCK-**-*- 31PST1</i>	<b>2.040</b> 51.82	<b>1.800</b> 45.72	<b>1.115</b> 28.32	<b>1.575</b> 40.01	<b>.8838</b> 22.45	<b>.308</b> 7.83
<i>MCK-**-*- 31SST1</i>	<b>2.040</b> 51.82	<b>1.800</b> 45.72	<b>1.115</b> 28.32	<b>1.575</b> 40.01	<b>.9518</b> 24.18	<b>.308</b> 7.83
<i>MCK-**-*- 37PST1</i>	<b>2.340</b> 59.44	<b>2.100</b> 53.34	<b>1.265</b> 32.13	<b>1.875</b> 47.63	<b>1.0338</b> 26.26	<b>.308</b> 7.83
<i>MCK-**-*- 37SST1</i>	<b>2.340</b> 59.44	<b>2.100</b> 53.34	<b>1.265</b> 32.13	<b>1.875</b> 47.63	<b>1.1018</b> 27.99	<b>.308</b> 7.83
<i>MCK-**-*- 51PST1</i>	<b>2.270</b> 57.66	<b>2.000</b> 50.80	<b>1.215</b> 30.86	<b>1.775</b> 45.09	<b>.9838</b> 24.99	<b>.351</b> 8.92
<i>MCK-**-*- 51SST1</i>	<b>2.280</b> 57.91	<b>2.000</b> 50.80	<b>1.215</b> 30.86	<b>1.775</b> 45.09	<b>1.0518</b> 26.72	<b>.351</b> 8.92
<i>MCK-**-*- 100PST1</i>	<b>3.250</b> 82.55	<b>2.800</b> 71.12	<b>1.800</b> 45.72	<b>2.585</b> 65.66	<b>1.3838</b> 35.15	<b>.460</b> 11.68
<i>MCK-**-*- 100SST1</i>	<b>3.250</b> 82.55	<b>2.800</b> 71.12	<b>1.800</b> 45.72	<b>2.585</b> 65.66	<b>1.508</b> 38.30	<b>.460</b> 11.68

P = Pin, S = Socket

Note: Items in bold italic are qualified to MIL-DTL-83513.



**MICRODOT MCK Transition Blocks (Continued)**

**ST1 — Straight Termination Configuration (Continued)**

View is of termination side of plug connector. For receptacle, use mirror image.

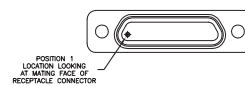
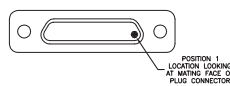
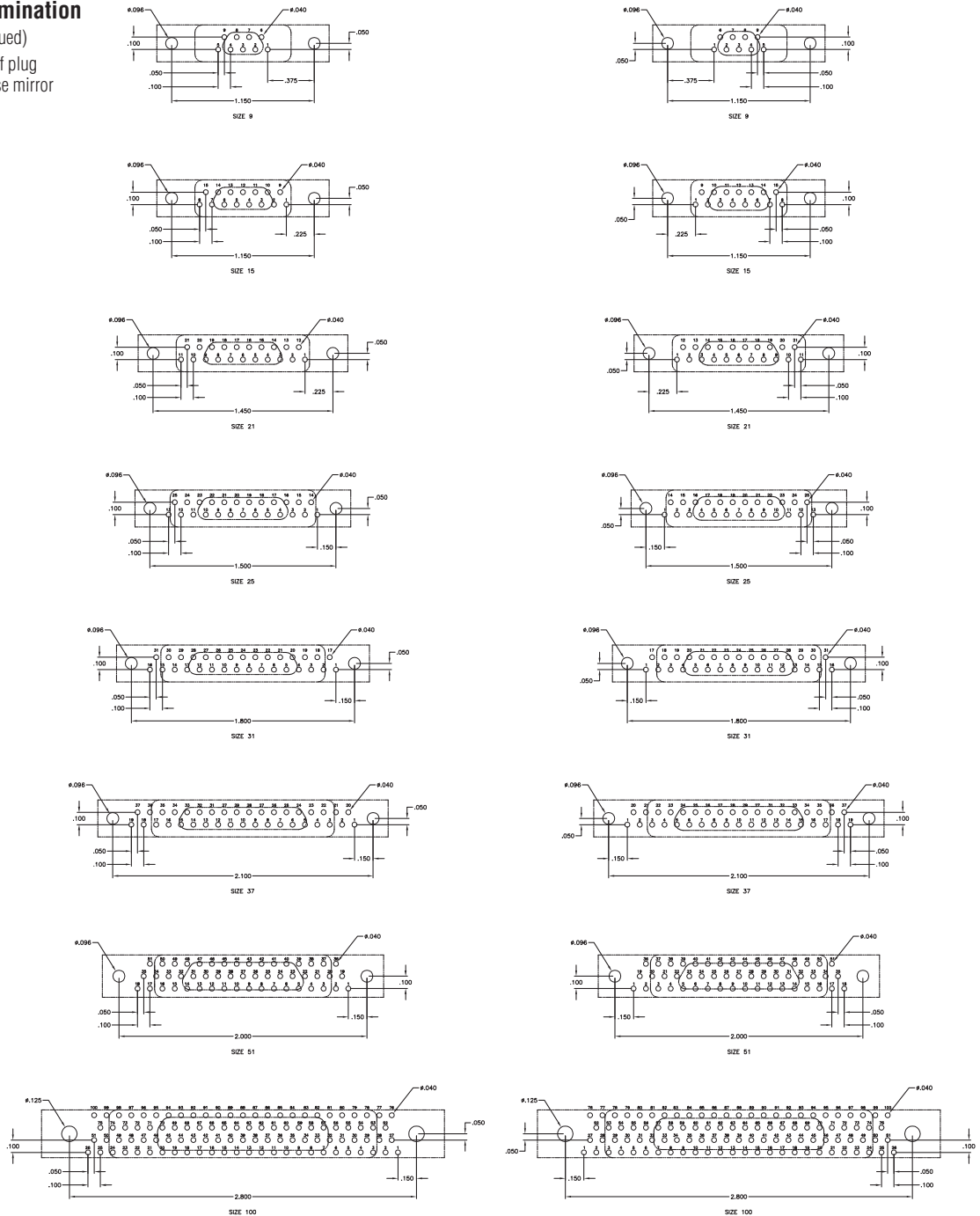

**MICRODOT MCK ST2 Series Straight Mount PCB Connectors**

**MCK with Cactus Bend Termination**

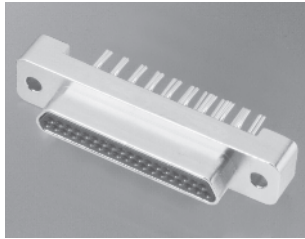

- Meets MIL-DTL-83513 Performance requirements
- Single metal shell with no Transition Block
- Low profile and light weight
- .100 [2.54] x .075 [1.91] grid pattern
- Design allows lower cost construction

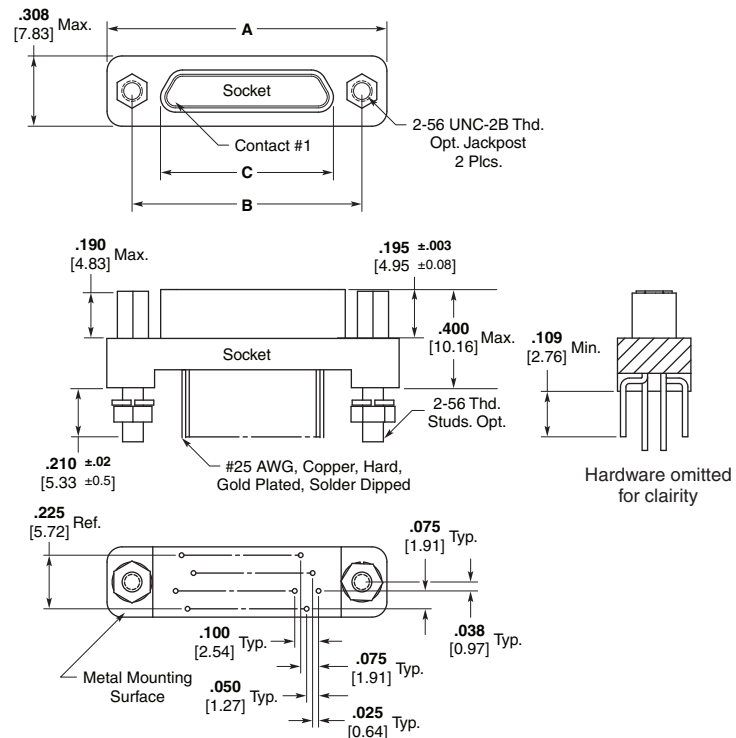
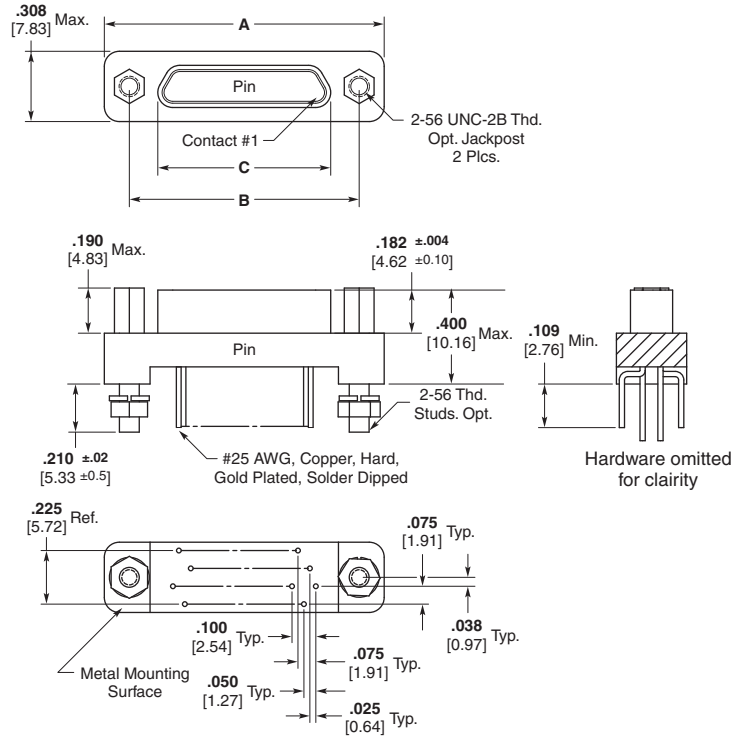

**MICRODOT MCK ST2 Series Straight Mount PCB Connectors** (Continued)

Part Number	A Max.	B ± .005	C Max.
MCK-**-*- 9 PST2	.785 19.94	.565 14.35	.333 8.46
MCK-**-*- 9 SST2	.785 19.94	.565 14.35	.402 10.21
MCK-**-*- 15 PST2	.935 23.75	.715 18.16	.483 12.27
MCK-**-*- 15 SST2	.935 23.75	.715 18.16	.552 14.02
MCK-**-*- 21 PST2	1.085 27.56	.865 21.97	.633 16.08
MCK-**-*- 21 SST2	1.085 27.56	.865 21.97	.702 17.83
MCK-**-*- 25 PST2	1.185 30.10	.965 24.51	.733 18.62
MCK-**-*- 25 SST2	1.185 30.10	.965 24.51	.802 20.37
MCK-**-*- 31 PST2	1.335 33.91	1.115 28.32	.883 22.43
MCK-**-*- 31 SST2	1.335 33.91	1.115 28.32	.952 24.18
MCK-**-*- 37 PST2	1.485 37.72	1.265 32.13	1.033 26.24
MCK-**-*- 37 SST2	1.485 37.72	1.265 32.13	1.102 27.99

**How To Specify**

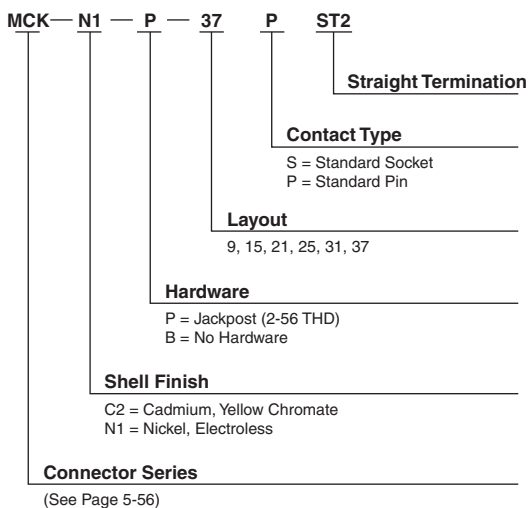

MICRODOT MCK ST2 Series Straight Mount PCB Connectors (Continued)

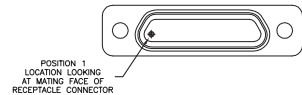
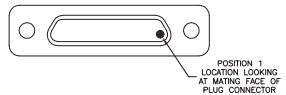
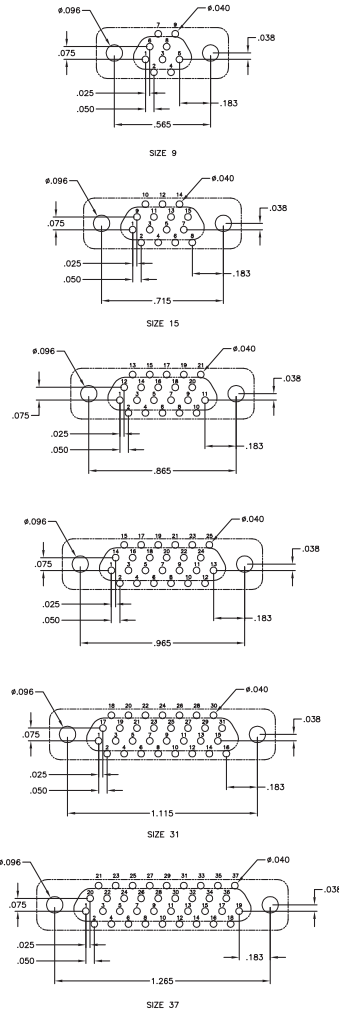
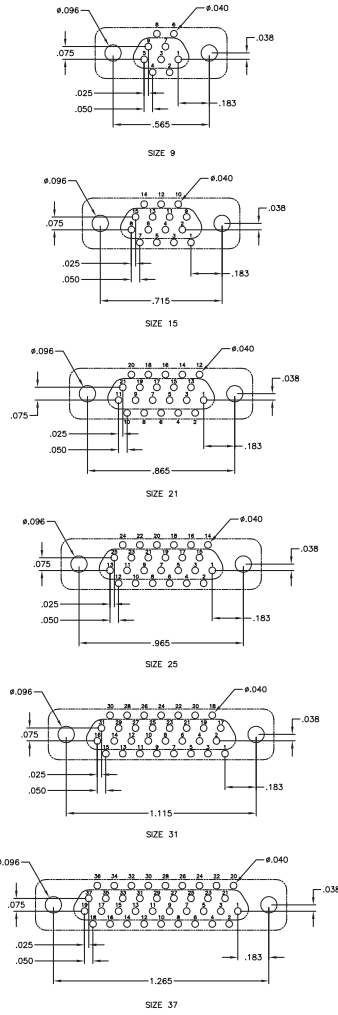

5  
Nanominature and Microminiature Connectors

**MICRODOT MCDM Series Metal Shell Connectors**

**Technical & Performance Data**

**Performance**

**Contact Resistance** — The average mated contact resistance is 4 milliohms, with a maximum value of 8 milliohms, using standard #24 solid copper leads when measured directly behind the crimp joints of the mated pin and socket contacts. The average resistance value at 100 microvolts is 4.8 milliohms.

**Dielectric Withstanding Voltage (60 Hz rms room temperature)** — Solder Pots — 600 VAC at sea level; 150 VAC at 70,000 feet [21,336 m].

Wire Terminations — 750 VAC at sea level; 200 VAC at 70,000 feet [21,336m]

**Vibration (Per MIL-STD-202C, Method 204-A, Condition D)** — No discontinuity in excess of 1 microsecond during twelve 20 minute sweeps from 10 to 2,000 CPS at .06 double amplitude or 20 G forces, whichever is less.

**Corrosion Resistance (Per MIL-STD-202C, Method 101B, Condition B)** — Both mated and unmated samples do not exceed the

maximum allowable contact resistance (8 milliohms) when subjected to the 48 hour salt spray test.

**Durability** — The contact resistance after 500 mating cycles is less than the maximum allowable, 8 milliohms.

**Insulation Resistance** — Greater than 5,000 megohms at room temperature for the materials listed under "Materials".

**Maximum Current Carrying Capacity** — No. 24 contact, 3 amperes. It must be recognized, however, that all the wires to a connector will not carry their maximum current under all environmental conditions due to wire temperature.

**Contact Engaging and Separation Forces** — 6 oz. [1.67N] maximum (eng.); 0.5 oz. [1.4N] minimum (sep.).

**Temperature Range (Operating)** — Diallyl phthalate -67°F to 257°F [-55°C to +125°C].

**Materials**

**Insulator** — Diallyl phthalate per MIL-M-14, Type SDG-F, Liquid Crystal Polymer (LCP) per ASTM D5138, or RYTON per ASTM D4067.

**Contacts** —

Pin Contact — Copper alloy and beryllium copper alloy make up the complete construction.

Socket Contact — Copper alloy.

**Body Shell** — High grade aluminum alloy.

**Finishes**

**Contacts** — Standard finish is 0.000050 [0.00127] gold over copper flash per MIL-G-45204, Type II.

**Body Shell** — Electroless nickel per AMS 2404.

**Note:**

Insulators are molded into their metal shells — No bonded joint is used.

**Screw Mount**



The only metal shell connector that mates with all existing plastic types. This line is ideal for external use and other applications requiring frequent disconnect and remating. When durability and reliability are paramount the metal shell connector is unsurpassed — it eliminates the need for retrofitting where new metal shell varieties must mate with older plastic types.

Originally designed for military applications, they are currently used for commercial requirements, including computers.

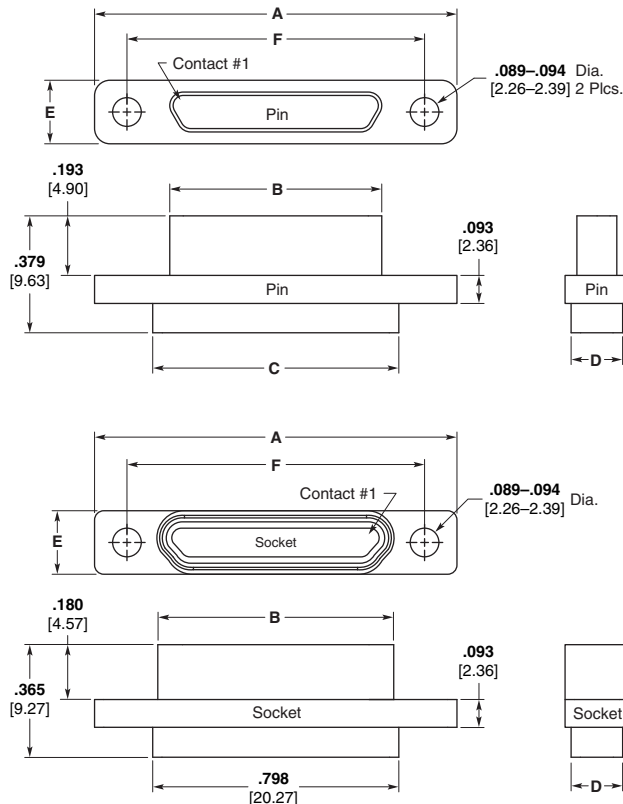

RYTON is a trademark of Chevron Chemical Company LLC.

**MICRODOT MCDM Series Metal Shell Connectors (Continued)**

**Screw Mount (Continued)**

**How To Specify**

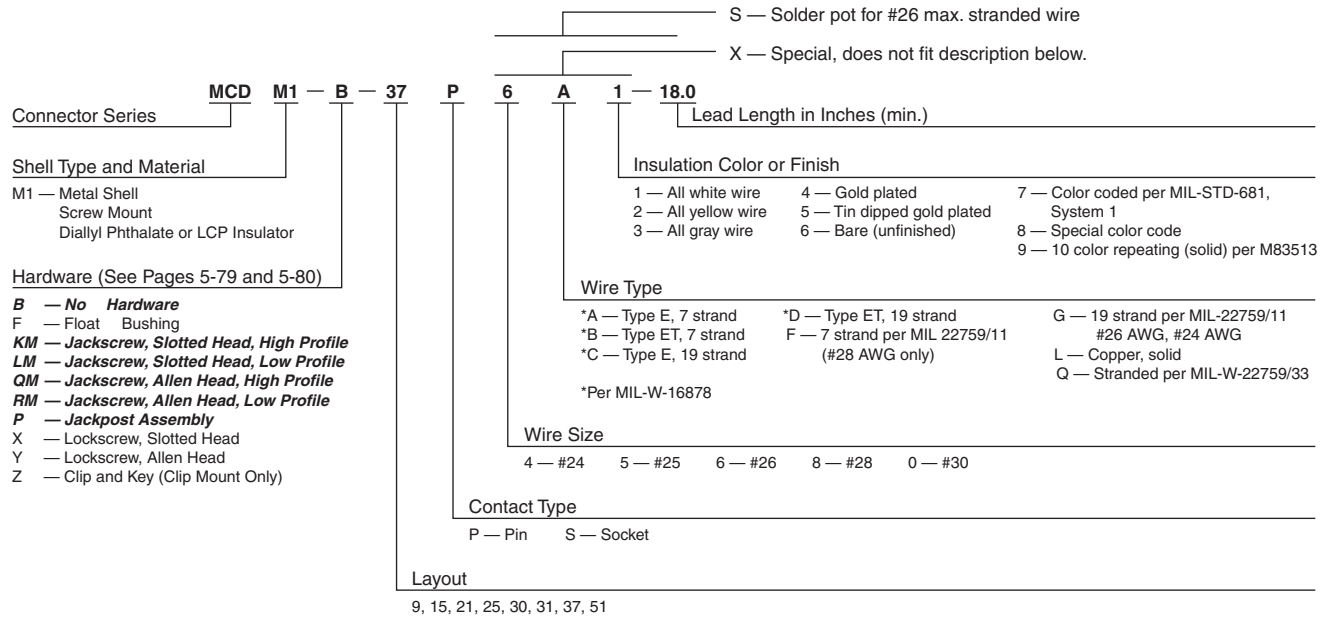

5 Nanominiature and Microminiature Connectors

Part Number	A ± .005 [±.127]	B ± .005 [±.127]	C ± .010 [±.254]	D ± .010 [±.254]	E ± .005 [±.127]	F ± .005 [±.127]	Avg. Weight lbs. ± 5% [grams]
MCDM1-9P***	.780 19.81	.290 7.36	.398 10.11	.165 4.19	.208 5.28	.565 14.35	.003 1.36
MCDM1-9S***	.780 19.81	.365 9.27	.398 10.11	.165 4.19	.208 5.28	.565 14.35	.003 1.36
MCDM1-15P***	.930 23.62	.440 11.18	.548 13.92	.165 4.19	.208 5.28	.715 18.16	.004 1.81
MCDM1-15S***	.930 23.62	.515 13.08	.548 13.92	.165 4.19	.208 5.28	.715 18.16	.004 1.81
MCDM1-21P***	1.080 27.43	.590 14.99	.698 17.73	.165 4.19	.208 5.28	.865 21.97	.005 2.26
MCDM1-21S***	1.080 27.43	.665 16.89	.698 17.73	.165 4.19	.208 5.28	.865 21.97	.005 2.26
MCDM1-25P***	1.180 29.97	.690 17.53	.798 20.27	.165 4.19	.208 5.28	.965 24.51	.006 2.72
MCDM1-25S***	1.180 29.97	.765 19.43	.798 20.27	.165 4.19	.208 5.28	.965 24.51	.005 2.26
MCDM1-30P***	.930 23.62	.435 11.05	.548 13.92	.252 6.40	.295 7.49	.715 18.16	.007 3.17
MCDM1-30S***	.930 23.62	.515 13.08	.548 13.92	.252 6.40	.295 7.49	.715 18.16	.007 3.17
MCDM1-31P***	1.330 33.78	.840 21.34	.948 16.46	.165 4.19	.208 5.28	1.115 28.32	.007 3.17
MCDM1-31S***	1.330 33.78	.915 23.24	.948 16.46	.165 4.19	.208 5.28	1.115 28.32	.006 2.72
MCDM1-37P***	1.480 37.59	.990 25.15	1.098 27.89	.165 4.19	.208 5.28	1.270 32.26	.007 3.17
MCDM1-37S***	1.480 37.59	1.065 27.05	1.098 27.89	.165 4.19	.208 5.28	1.270 32.26	.007 3.17
MCDM1-51P***	1.430 36.32	.940 23.88	1.048 26.62	.208 5.28	.250 6.35	1.215 30.86	.009 4.08
MCDM1-51S***	1.430 36.32	1.015 25.78	1.048 26.62	.208 5.28	.250 6.35	1.215 30.86	.008 3.62

**Note:** Weight given is with .500 [12.7] uninsulated, solid, 24 AWG gold plated copper pigtailed.

**MICRODOT MCDM Series Metal Shell RF COMBOMATE Connectors**

**Screw Mount Coaxial Terminations**

Available *now* — RF Performance in standard subminiature rectangular connectors, with VSWR values of 1.01 to 1.10 in frequencies ranging in DC to 2.3 GHz. This is the COMBOMATE Connector.

This series of connectors incorporates the same metal shells and twist pin contacts used in the widely accepted, high reliability, MCDM Series.

The RF COMBOMATE Connector Series will accommodate RG 196 A/U or RG 178 B/U coaxial cable terminated in a unique, already tooled insert layouts. This feature results in savings in cost, time and space.

The RF COMBOMATE Connector Series will accommodate a maximum of 17 RG 196 A/U or RG 178 B/U cables in an area of less than .225 sq. inches [14.51 mm<sup>2</sup>]. Mixed layouts with coaxial terminations and standard AWG 24, 26 and 28 are also immediately available in 7 different shell sizes. The overall envelope and mounting dimensions of equivalent size of COMBOMATE Connectors are exactly the same as the standard MCDM Series.

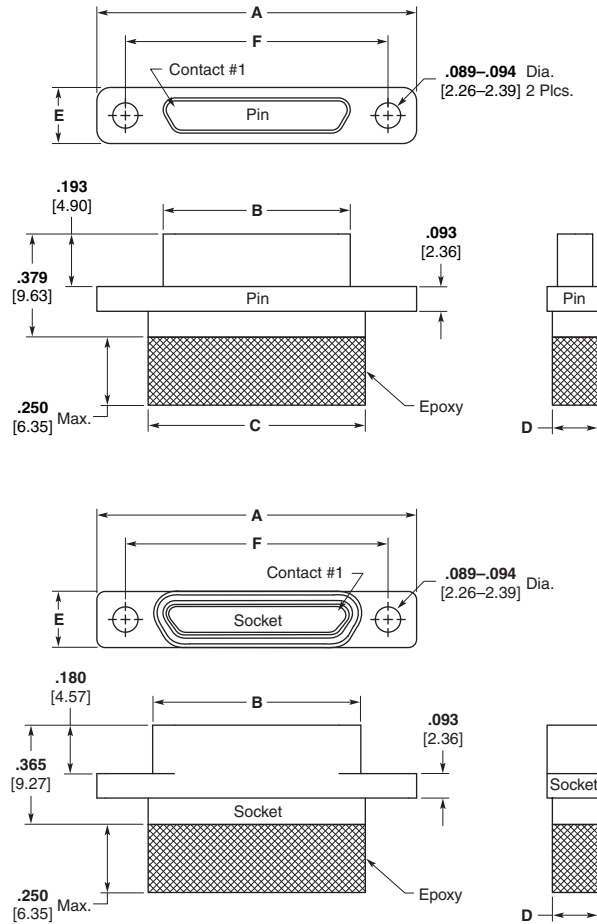

**Performance Data — Coaxial Terminations**

**Impedance** — 49.0 to 51.0 Ohms.

**Voltage Standing Wave Ratio (VSWR)** — 1.01:1 to 1.10:1 at frequency ranging in DC to 2.3 GHz.

**Dielectric Withstanding Voltage (60 Hz rms room temperature)** — 750 VAC at sea level; 200 VAC at 70,000 feet [21,336 m].

	(Actual Test Data) Crosstalk (Between Adjacent Lines)			
	1 to 2	2 to 3	3 to 4	4 to 5
30 MHz	60.0 db	59.8 db	60.7 db	60.0 db
100 MHz	49.1 db	48.3 db	51.7 db	50.6 db
175 MHz	42.6 db	41.4 db	47.2 db	47.0 db
500 MHz	38.0 db	38.8 db	39.5 db	40.0 db
1000 MHz	31.6 db	32.0 db	30.0 db	32.5 db
2000 MHz	22.4 db	22.5 db	22.3 db	20.8 db
3000 MHz	21.5 db	23.9 db	21.4 db	24.2 db

Sample	Insertion Loss				
	#1	#2	#3	#4	#5
30 MHz	.08 db	.08 db	.08 db	.08 db	.08 db
100 MHz	.24 db	.24 db	.25 db	.25 db	.25 db
175 MHz	.35 db	.36 db	.36 db	.34 db	.32 db
500 MHz	.58 db	.50 db	.60 db	.58 db	.48 db
1000 MHz	1.25 db	1.33 db	1.36 db	1.35 db	1.24 db
2000 MHz	1.48 db	1.71 db	1.42 db	1.40 db	1.45 db
3000 MHz	2.66 db	2.45 db	2.74 db	2.86 db	2.84 db

**Note:** Verification of all test data is on file at TE Connectivity and is available upon request. All test runs using RG 196 A/U.

**MICRODOT MCDM Series Metal Shell RF COMBOMATE Connectors** (Continued)

**Screw Mount Coaxial Terminations** (Continued)

**How To Specify**

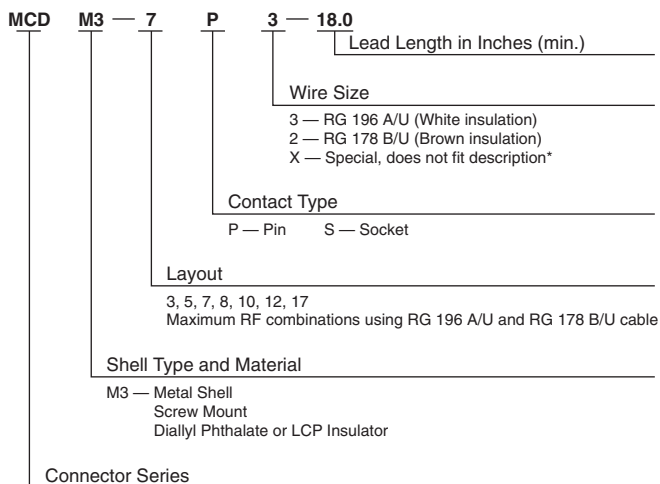

**\*Ordering Criteria:** A wide variety of contact combinations, coaxial and power mixed, are available. Contact TE Connectivity for additional arrangement numbers.

Part Number	A ± .005 [± .127]	B ± .005 [± .127]	C Max.	D Max.	E ± .005 [± .127]	F ± .005 [± .127]
MCDM3-3P**	.780 19.81	.290 7.36	.408 10.36	.200 5.08	.208 5.28	.565 14.35
MCDM3-3S**	.780 19.81	.365 9.27	.408 10.36	.200 5.08	.208 5.28	.565 14.35
MCDM3-5P**	.930 23.62	.440 11.18	.558 14.17	.200 5.08	.208 5.28	.715 18.16
MCDM3-5S**	.930 23.62	.515 13.08	.558 14.17	.200 5.08	.208 5.28	.715 18.16
MCDM3-7P**	1.080 27.43	.590 14.99	.708 17.98	.200 5.08	.208 5.28	.865 21.97
MCDM3-7S**	1.080 27.43	.665 16.89	.708 17.98	.200 5.08	.208 5.28	.865 21.97
MCDM3-8P**	1.180 29.97	.690 17.53	.808 20.52	.200 5.08	.208 5.28	.965 24.51
MCDM3-8S**	1.180 29.97	.765 19.43	.808 20.52	.200 5.08	.208 5.28	.965 24.51
MCDM3-10P**	1.330 33.78	.840 21.34	.958 24.33	.200 5.08	.208 5.28	1.115 28.32
MCDM3-10S**	1.330 33.78	.915 23.24	.958 24.33	.200 5.08	.208 5.28	1.115 28.32
MCDM3-12P**	1.480 37.59	.990 25.15	1.108 27.89	.200 5.08	.208 5.28	1.270 32.26
MCDM3-12S**	1.480 37.59	1.065 27.05	1.108 27.89	.200 5.08	.208 5.28	1.270 32.26
MCDM3-17P**	1.430 36.32	.940 23.88	1.058 26.87	.245 6.22	.250 6.35	1.215 30.86
MCDM3-17S**	1.430 36.32	1.015 25.78	1.058 26.87	.245 6.22	.250 6.35	1.215 30.86



**MICRODOT MCDM Series Metal Shell RF COMBOMATE Connectors** (Continued)

**Contact Arrangement as Viewed from the Engaging Face of the Pin Side**

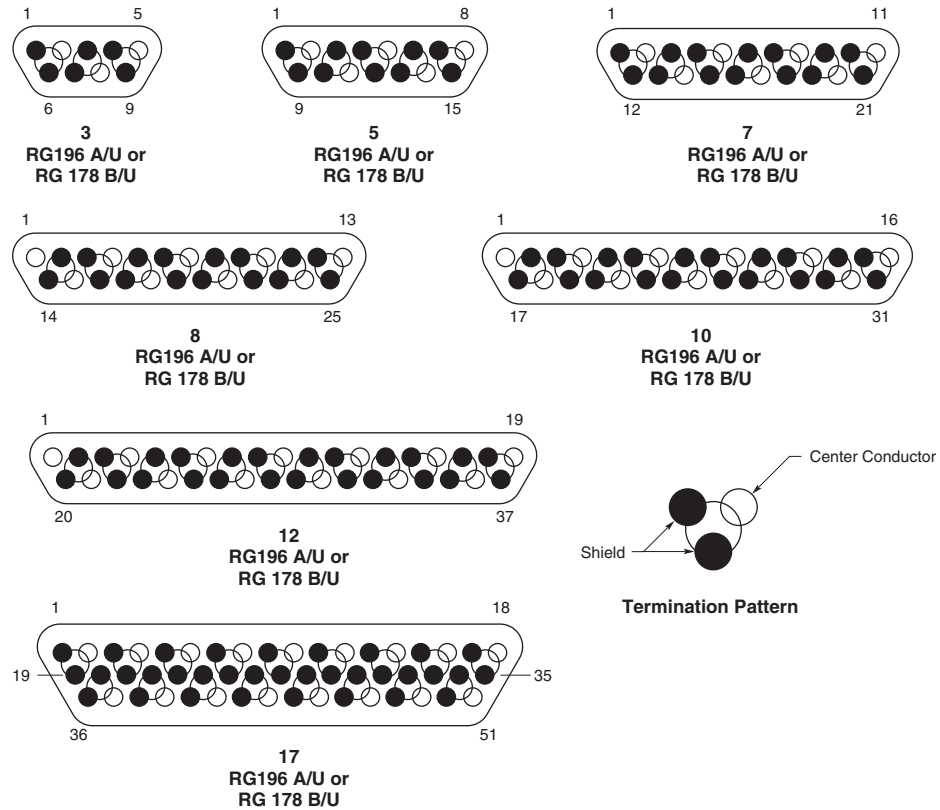

**Note:** The above contact arrangements are the maximum densities that can be obtained in each shell size when using RG 196 A/U or RG 178 B/U cable.

**MICRODOT MCDM Series Metal Shell Connectors Panel Mounting — Cutout Dimensions**

**Panel Mounting Dimensions — MCDM**

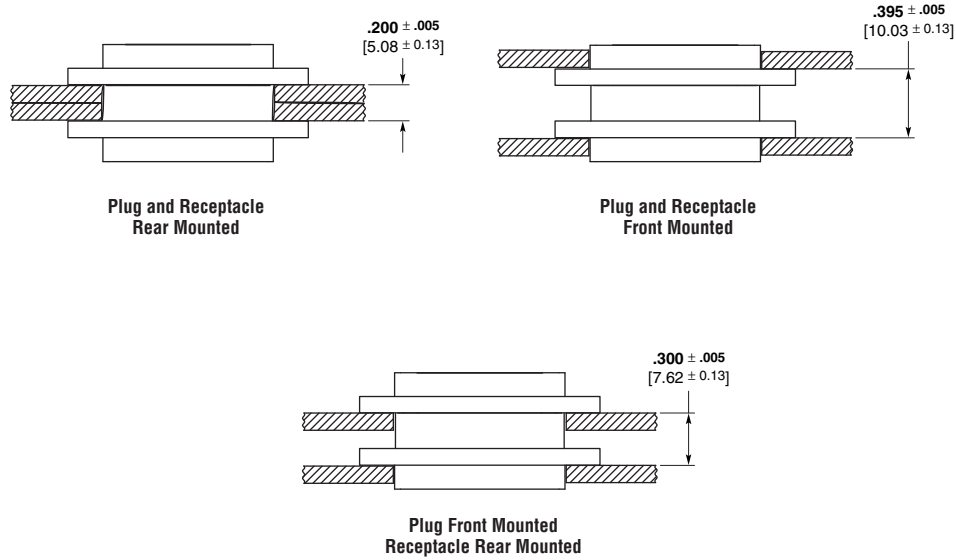

**Panel Cutout Dimensions**

**Screw Mounting**

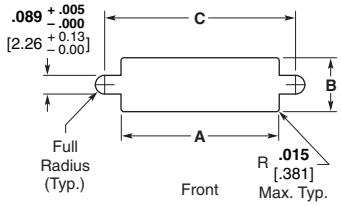

Figure 1

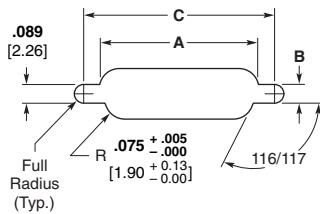

Figure 2

Note: Front mounting preferred.

Number of Contacts	Fig.	A		B		C	
		+ .004 [+ .102]	- .000 [- .000]	+ .004 [+ .102]	- .000 [- .000]	+ .005 [+ .127]	- .000 [- .000]
9	1	.412 [10.46]	.177 [4.50]	.570 [14.48]			
	2	.384 [9.75]	.222 [5.64]	.570 [14.48]			
15	1	.562 [14.27]	.177 [4.50]	.720 [18.29]			
	2	.534 [13.56]	.222 [5.64]	.720 [18.29]			
21	1	.712 [18.08]	.177 [4.50]	.870 [22.10]			
	2	.684 [17.37]	.222 [5.64]	.870 [22.10]			
25	1	.812 [20.62]	.177 [4.50]	.970 [24.64]			
	2	.784 [19.91]	.222 [5.64]	.970 [24.64]			
31	1	.962 [24.43]	.177 [4.50]	1.120 [28.45]			
	2	.934 [23.72]	.222 [5.64]	1.120 [28.45]			
37	1	1.112 [28.24]	.177 [4.50]	1.270 [32.26]			
	2	1.084 [27.53]	.222 [5.64]	1.270 [32.26]			
51	1	1.062 [26.97]	.224 [5.69]	1.220 [30.99]			
	2	1.034 [26.26]	.264 [6.71]	1.220 [30.99]			

**MIL-DTL-83513 Cross Reference**

**MCKS (Metal Shell)**

Military Part No.	MICRODOT Part No.
M83513/01-A*	MCKS**-B- 9PS
M83513/01-B*	MCKS**-B- 15PS
M83513/01-C*	MCKS**-B- 21PS
M83513/01-D*	MCKS**-B- 25PS
M83513/01-E*	MCKS**-B- 31PS
M83513/01-F*	MCKS**-B- 37PS
M83513/01-G*	MCKS**-B- 51PS
M83513/01-H*	MCKS**-B-100PS
M83513/02-A*	MCKS**-B- 9SS
M83513/02-B*	MCKS**-B- 15SS
M83513/02-C*	MCKS**-B- 21SS
M83513/02-D*	MCKS**-B- 25SS
M83513/02-E*	MCKS**-B- 31SS
M83513/02-F*	MCKS**-B- 37SS
M83513/02-G*	MCKS**-B- 51SS
M83513/02-H*	MCKS**-B-100SS
M83513/03-A01*	MCKS**-B- 9P6G1-18.0
M83513/03-B01*	MCKS**-B- 15P6G1-18.0
M83513/03-C01*	MCKS**-B- 21P6G1-18.0
M83513/03-D01*	MCKS**-B- 25P6G1-18.0
M83513/03-E01*	MCKS**-B- 31P6G1-18.0
M83513/03-F01*	MCKS**-B- 37P6G1-18.0
M83513/03-G01*	MCKS**-B- 51P6G1-18.0
M83513/03-H01*	MCKS**-B-100P6G1-18.0
M83513/03-A02*	MCKS**-B- 9P6G1-36.0
M83513/03-B02*	MCKS**-B- 15P6G1-36.0
M83513/03-C02*	MCKS**-B- 21P6G1-36.0
M83513/03-D02*	MCKS**-B- 25P6G1-36.0
M83513/03-E02*	MCKS**-B- 31P6G1-36.0
M83513/03-F02*	MCKS**-B- 37P6G1-36.0
M83513/03-G02*	MCKS**-B- 51P6G1-36.0
M83513/03-H02*	MCKS**-B-100P6G1-36.0
M83513/03-A03*	MCKS**-B- 9P6G9-18.0
M83513/03-B03*	MCKS**-B- 15P6G9-18.0
M83513/03-C03*	MCKS**-B- 21P6G9-18.0
M83513/03-D03*	MCKS**-B- 25P6G9-18.0
M83513/03-E03*	MCKS**-B- 31P6G9-18.0
M83513/03-F03*	MCKS**-B- 37P6G9-18.0
M83513/03-G03*	MCKS**-B- 51P6G9-18.0
M83513/03-H03*	MCKS**-B-100P6G9-18.0
M83513/03-A04*	MCKS**-B- 9P6G9-36.0
M83513/03-B04*	MCKS**-B- 15P6G9-36.0
M83513/03-C04*	MCKS**-B- 21P6G9-36.0
M83513/03-D04*	MCKS**-B- 25P6G9-36.0
M83513/03-E04*	MCKS**-B- 31P6G9-36.0
M83513/03-F04*	MCKS**-B- 37P6G9-36.0
M83513/03-G04*	MCKS**-B- 51P6G9-36.0
M83513/03-H04*	MCKS**-B-100P6G9-36.0
M83513/03-A05*	MCKS**-B- 9P5L4-0.5
M83513/03-B05*	MCKS**-B- 15P5L4-0.5
M83513/03-C05*	MCKS**-B- 21P5L4-0.5
M83513/03-D05*	MCKS**-B- 25P5L4-0.5
M83513/03-E05*	MCKS**-B- 31P5L4-0.5
M83513/03-F05*	MCKS**-B- 37P5L4-0.5
M83513/03-G05*	MCKS**-B- 51P5L4-0.5
M83513/03-H05*	MCKS**-B-100P5L4-0.5
M83513/03-A06*	MCKS**-B- 9P5L4-1.0
M83513/03-B06*	MCKS**-B- 15P5L4-1.0
M83513/03-C06*	MCKS**-B- 21P5L4-1.0
M83513/03-D06*	MCKS**-B- 25P5L4-1.0

Military Part No.	MICRODOT Part No.
M83513/03-E06*	MCKS**-B- 31P5L4-1.0
M83513/03-F06*	MCKS**-B- 37P5L4-1.0
M83513/03-G06*	MCKS**-B- 51P5L4-1.0
M83513/03-H06*	MCKS**-B-100P5L4-1.0
M83513/03-A07*	MCKS**-B- 9P5L5-0.5
M83513/03-B07*	MCKS**-B- 15P5L5-0.5
M83513/03-C07*	MCKS**-B- 21P5L5-0.5
M83513/03-D07*	MCKS**-B- 25P5L5-0.5
M83513/03-E07*	MCKS**-B- 31P5L5-0.5
M83513/03-F07*	MCKS**-B- 37P5L5-0.5
M83513/03-G07*	MCKS**-B- 51P5L5-0.5
M83513/03-H07*	MCKS**-B-100P5L5-0.5
M83513/03-A08*	MCKS**-B- 9P5L5-1.0
M83513/03-B08*	MCKS**-B- 15P5L5-1.0
M83513/03-C08*	MCKS**-B- 21P5L5-1.0
M83513/03-D08*	MCKS**-B- 25P5L5-1.0
M83513/03-E08*	MCKS**-B- 31P5L5-1.0
M83513/03-F08*	MCKS**-B- 37P5L5-1.0
M83513/03-G08*	MCKS**-B- 51P5L5-1.0
M83513/03-H08*	MCKS**-B-100P5L5-1.0
M83513/03-A09*	MCKS**-B- 9P6Q1-18.0
M83513/03-B09*	MCKS**-B- 15P6Q1-18.0
M83513/03-C09*	MCKS**-B- 21P6Q1-18.0
M83513/03-D09*	MCKS**-B- 25P6Q1-18.0
M83513/03-E09*	MCKS**-B- 31P6Q1-18.0
M83513/03-F09*	MCKS**-B- 37P6Q1-18.0
M83513/03-G09*	MCKS**-B- 51P6Q1-18.0
M83513/03-H09*	MCKS**-B-100P6Q1-18.0
M83513/03-A10*	MCKS**-B- 9P6Q1-36.0
M83513/03-B10*	MCKS**-B- 15P6Q1-36.0
M83513/03-C10*	MCKS**-B- 21P6Q1-36.0
M83513/03-D10*	MCKS**-B- 25P6Q1-36.0
M83513/03-E10*	MCKS**-B- 31P6Q1-36.0
M83513/03-F10*	MCKS**-B- 37P6Q1-36.0
M83513/03-G10*	MCKS**-B- 51P6Q1-36.0
M83513/03-H10*	MCKS**-B-100P6Q1-36.0
M83513/03-A11*	MCKS**-B- 9P6Q9-18.0
M83513/03-B11*	MCKS**-B- 15P6Q9-18.0
M83513/03-C11*	MCKS**-B- 21P6Q9-18.0
M83513/03-D11*	MCKS**-B- 25P6Q9-18.0
M83513/03-E11*	MCKS**-B- 31P6Q9-18.0
M83513/03-F11*	MCKS**-B- 37P6Q9-18.0
M83513/03-G11*	MCKS**-B- 51P6Q9-18.0
M83513/03-H11*	MCKS**-B-100P6Q9-18.0
M83513/03-A12*	MCKS**-B- 9P6Q9-36.0
M83513/03-B12*	MCKS**-B- 15P6Q9-36.0
M83513/03-C12*	MCKS**-B- 21P6Q9-36.0
M83513/03-D12*	MCKS**-B- 25P6Q9-36.0
M83513/03-E12*	MCKS**-B- 31P6Q9-36.0
M83513/03-F12*	MCKS**-B- 37P6Q9-36.0
M83513/03-G12*	MCKS**-B- 51P6Q9-36.0
M83513/03-H12*	MCKS**-B-100P6Q9-36.0
M83513/03-A13*	MCKS**-B- 9P6G1-72.0
M83513/03-B13*	MCKS**-B- 15P6G1-72.0
M83513/03-C13*	MCKS**-B- 21P6G1-72.0
M83513/03-D13*	MCKS**-B- 25P6G1-72.0
M83513/03-E13*	MCKS**-B- 31P6G1-72.0
M83513/03-F13*	MCKS**-B- 37P6G1-72.0
M83513/03-G13*	MCKS**-B- 51P6G1-72.0
M83513/03-H13*	MCKS**-B-100P6G1-72.0

Military Part No.	MICRODOT Part No.
M83513/03-A14*	MCKS**-B- 9P6G9-72.0
M83513/03-B14*	MCKS**-B- 15P6G9-72.0
M83513/03-C14*	MCKS**-B- 21P6G9-72.0
M83513/03-D14*	MCKS**-B- 25P6G9-72.0
M83513/03-E14*	MCKS**-B- 31P6G9-72.0
M83513/03-F14*	MCKS**-B- 37P6G9-72.0
M83513/03-G14*	MCKS**-B- 51P6G9-72.0
M83513/03-H14*	MCKS**-B-100P6G9-72.0
M83513/03-A15*	MCKS**-B- 9P6Q1-72.0
M83513/03-B15*	MCKS**-B- 15P6Q1-72.0
M83513/03-C15*	MCKS**-B- 21P6Q1-72.0
M83513/03-D15*	MCKS**-B- 25P6Q1-72.0
M83513/03-E15*	MCKS**-B- 31P6Q1-72.0
M83513/03-F15*	MCKS**-B- 37P6Q1-72.0
M83513/03-G15*	MCKS**-B- 51P6Q1-72.0
M83513/03-H15*	MCKS**-B-100P6Q1-72.0
M83513/03-A16*	MCKS**-B- 9P6Q9-72.0
M83513/03-B16*	MCKS**-B- 15P6Q9-72.0
M83513/03-C16*	MCKS**-B- 21P6Q9-72.0
M83513/03-D16*	MCKS**-B- 25P6Q9-72.0
M83513/03-E16*	MCKS**-B- 31P6Q9-72.0
M83513/03-F16*	MCKS**-B- 37P6Q9-72.0
M83513/03-G16*	MCKS**-B- 51P6Q9-72.0
M83513/03-H16*	MCKS**-B-100P6Q9-72.0
M83513/04-A01*	MCKS**-B- 9S6G1-18.0
M83513/04-B01*	MCKS**-B- 15S6G1-18.0
M83513/04-C01*	MCKS**-B- 21S6G1-18.0
M83513/04-D01*	MCKS**-B- 25S6G1-18.0
M83513/04-E01*	MCKS**-B- 31S6G1-18.0
M83513/04-F01*	MCKS**-B- 37S6G1-18.0
M83513/04-G01*	MCKS**-B- 51S6G1-18.0
M83513/04-H01*	MCKS**-B-100S6G1-18.0
M83513/04-A02*	MCKS**-B- 9S6G1-36.0
M83513/04-B02*	MCKS**-B- 15S6G1-36.0
M83513/04-C02*	MCKS**-B- 21S6G1-36.0
M83513/04-D02*	MCKS**-B- 25S6G1-36.0
M83513/04-E02*	MCKS**-B- 31S6G1-36.0
M83513/04-F02*	MCKS**-B- 37S6G1-36.0
M83513/04-G02*	MCKS**-B- 51S6G1-36.0
M83513/04-H02*	MCKS**-B-100S6G1-36.0
M83513/04-A03*	MCKS**-B- 9S6G9-18.0
M83513/04-B03*	MCKS**-B- 15S6G9-18.0
M83513/04-C03*	MCKS**-B- 21S6G9-18.0
M83513/04-D03*	MCKS**-B- 25S6G9-18.0
M83513/04-E03*	MCKS**-B- 31S6G9-18.0
M83513/04-F03*	MCKS**-B- 37S6G9-18.0
M83513/04-G03*	MCKS**-B- 51S6G9-18.0
M83513/04-H03*	MCKS**-B-100S6G9-18.0
M83513/04-A04*	MCKS**-B- 9S6G9-36.0
M83513/04-B04*	MCKS**-B- 15S6G9-36.0
M83513/04-C04*	MCKS**-B- 21S6G9-36.0
M83513/04-D04*	MCKS**-B- 25S6G9-36.0
M83513/04-E04*	MCKS**-B- 31S6G9-36.0
M83513/04-F04*	MCKS**-B- 37S6G9-36.0
M83513/04-G04*	MCKS**-B- 51S6G9-36.0
M83513/04-H04*	MCKS**-B-100S6G9-36.0
M83513/04-A05*	MCKS**-B- 9S5L4-0.5
M83513/04-B05*	MCKS**-B- 15S5L4-0.5
M83513/04-C05*	MCKS**-B- 21S5L4-0.5
M83513/04-D05*	MCKS**-B- 25S5L4-0.5

**MIL-DTL-83513 Cross Reference** (Continued)

**MCKS (Metal Shell)** (Continued)

Military Part No.	MICRODOT Part No.	Military Part No.	MICRODOT Part No.	Military Part No.	MICRODOT Part No.
M83513/04-E05*	MCKS**-B- 31S5L4-0.5	M83513/04-D09*	MCKS**-B- 25S6Q1-18.0	M83513/04-C13*	MCKS**-B- 21S6G1-72.0
M83513/04-F05*	MCKS**-B- 37S5L4-0.5	M83513/04-E09*	MCKS**-B- 31S6Q1-18.0	M83513/04-D13*	MCKS**-B- 25S6G1-72.0
M83513/04-G05*	MCKS**-B- 51S5L4-0.5	M83513/04-F09*	MCKS**-B- 37S6Q1-18.0	M83513/04-E13*	MCKS**-B- 31S6G1-72.0
M83513/04-H05*	MCKS**-B-100S5L4-0.5	M83513/04-G09*	MCKS**-B- 51S6Q1-18.0	M83513/04-F13*	MCKS**-B- 37S6G1-72.0
M83513/04-A06*	MCKS**-B- 9S5L4-1.0	M83513/04-H09*	MCKS**-B-100S6Q1-18.0	M83513/04-G13*	MCKS**-B- 51S6G1-72.0
M83513/04-B06*	MCKS**-B- 15S5L4-1.0	M83513/04-A10*	MCKS**-B- 9S6Q1-36.0	M83513/04-H13*	MCKS**-B-100S6G1-72.0
M83513/04-C06*	MCKS**-B- 21S5L4-1.0	M83513/04-B10*	MCKS**-B- 15S6Q1-36.0	M83513/04-A14*	MCKS**-B- 9S6G9-72.0
M83513/04-D06*	MCKS**-B- 25S5L4-1.0	M83513/04-C10*	MCKS**-B- 21S6Q1-36.0	M83513/04-B14*	MCKS**-B- 15S6G9-72.0
M83513/04-E06*	MCKS**-B- 31S5L4-1.0	M83513/04-D10*	MCKS**-B- 25S6Q1-36.0	M83513/04-C14*	MCKS**-B- 21S6G9-72.0
M83513/04-F06*	MCKS**-B- 37S5L4-1.0	M83513/04-E10*	MCKS**-B- 31S6Q1-36.0	M83513/04-D14*	MCKS**-B- 25S6G9-72.0
M83513/04-G06*	MCKS**-B- 51S5L4-1.0	M83513/04-F10*	MCKS**-B- 37S6Q1-36.0	M83513/04-E14*	MCKS**-B- 31S6G9-72.0
M83513/04-H06*	MCKS**-B-100S5L4-1.0	M83513/04-G10*	MCKS**-B- 51S6Q1-36.0	M83513/04-F14*	MCKS**-B- 37S6G9-72.0
M83513/04-A07*	MCKS**-B- 9S5L5-0.5	M83513/04-H10*	MCKS**-B-100S6Q1-36.0	M83513/04-G14*	MCKS**-B- 51S6G9-72.0
M83513/04-B07*	MCKS**-B- 15S5L5-0.5	M83513/04-A11*	MCKS**-B- 9S6Q9-18.0	M83513/04-H14*	MCKS**-B-100S6G9-72.0
M83513/04-C07*	MCKS**-B- 21S5L5-0.5	M83513/04-B11*	MCKS**-B- 15S6Q9-18.0	M83513/04-A15*	MCKS**-B- 9S6Q1-72.0
M83513/04-D07*	MCKS**-B- 25S5L5-0.5	M83513/04-C11*	MCKS**-B- 21S6Q9-18.0	M83513/04-B15*	MCKS**-B- 15S6Q1-72.0
M83513/04-E07*	MCKS**-B- 31S5L5-0.5	M83513/04-D11*	MCKS**-B- 25S6Q9-18.0	M83513/04-C15*	MCKS**-B- 21S6Q1-72.0
M83513/04-F07*	MCKS**-B- 37S5L5-0.5	M83513/04-E11*	MCKS**-B- 31S6Q9-18.0	M83513/04-D15*	MCKS**-B- 25S6Q1-72.0
M83513/04-G07*	MCKS**-B- 51S5L5-0.5	M83513/04-F11*	MCKS**-B- 37S6Q9-18.0	M83513/04-E15*	MCKS**-B- 31S6Q1-72.0
M83513/04-H07*	MCKS**-B-100S5L5-0.5	M83513/04-G11*	MCKS**-B- 51S6Q9-18.0	M83513/04-F15*	MCKS**-B- 37S6Q1-72.0
M83513/04-A08*	MCKS**-B- 9S5L5-1.0	M83513/04-H11*	MCKS**-B-100S6Q9-18.0	M83513/04-G15*	MCKS**-B- 51S6Q1-72.0
M83513/04-B08*	MCKS**-B- 15S5L5-1.0	M83513/04-A12*	MCKS**-B- 9S6Q9-36.0	M83513/04-H15*	MCKS**-B-100S6Q1-72.0
M83513/04-C08*	MCKS**-B- 21S5L5-1.0	M83513/04-B12*	MCKS**-B- 15S6Q9-36.0	M83513/04-A16*	MCKS**-B- 9S6Q9-72.0
M83513/04-D08*	MCKS**-B- 25S5L5-1.0	M83513/04-C12*	MCKS**-B- 21S6Q9-36.0	M83513/04-B16*	MCKS**-B- 15S6Q9-72.0
M83513/04-E08*	MCKS**-B- 31S5L5-1.0	M83513/04-D12*	MCKS**-B- 25S6Q9-36.0	M83513/04-C16*	MCKS**-B- 21S6Q9-72.0
M83513/04-F08*	MCKS**-B- 37S5L5-1.0	M83513/04-E12*	MCKS**-B- 31S6Q9-36.0	M83513/04-D16*	MCKS**-B- 25S6Q9-72.0
M83513/04-G08*	MCKS**-B- 51S5L5-1.0	M83513/04-F12*	MCKS**-B- 37S6Q9-36.0	M83513/04-E16*	MCKS**-B- 31S6Q9-72.0
M83513/04-H08*	MCKS**-B-100S5L5-1.0	M83513/04-G12*	MCKS**-B- 51S6Q9-36.0	M83513/04-F16*	MCKS**-B- 37S6Q9-72.0
M83513/04-A09*	MCKS**-B- 9S6Q1-18.0	M83513/04-H12*	MCKS**-B-100S6Q9-36.0	M83513/04-G16*	MCKS**-B- 51S6Q9-72.0
M83513/04-B09*	MCKS**-B- 15S6Q1-18.0	M83513/04-A13*	MCKS**-B- 9S6G1-72.0	M83513/04-H16*	MCKS**-B-100S6Q9-72.0
M83513/04-C09*	MCKS**-B- 21S6Q1-18.0	M83513/04-B13*	MCKS**-B- 15S6G1-72.0		

\*C = Cadmium or N = Nickel (space applications only)  
 \*\*C2 = Cadmium or N1 = Nickel (space applications only)

**Hardware**

Military Part No.	MICRODOT Part No.	Military Part No.	MICRODOT Part No.	Military Part No.	MICRODOT Part No.
M83513/05-02	"A. HD, J/S, L.F. #2"	M83513/05-05	"S. HD, J/S, L.F. #2"	M83513/05-07	"JACKPOST ASSY #2"
M83513/05-12	"A. HD, J/S, L.F. #4"	M83513/05-15	"S. HD, J/S, L.F. #4"	M83513/05-17	"JACKPOST ASSY, #4"
M83513/05-03	"A. HD, J/S,H.F. #2"	M83513/05-06	"S. HD, J/S, H.F. #2"		
M83513/05-13	"A. HD, J/S, H.F. #4"	M83513/05-16	"S. HD, J/S, H.F. #4"		

**MCDR (Plastic Shell)**

Military Part No.	MICRODOT Part No.	Military Part No.	MICRODOT Part No.	Military Part No.	MICRODOT Part No.
M83513/06-A	MCDR3-B- 9PS	M83513/07-G	MCDR3-B-51SS	M83513/08-F02	MCDR3-B-37P6G1-36.0
M83513/06-B	MCDR3-B-15PS	M83513/08-A01	MCDR3-B- 9P6G1-18.0	M83513/08-G02	MCDR3-B-51P6G1-36.0
M83513/06-C	MCDR3-B-21PS	M83513/08-B01	MCDR3-B-15P6G1-18.0	M83513/08-A03	MCDR3-B- 9P6G9-18.0
M83513/06-D	MCDR3-B-25PS	M83513/08-C01	MCDR3-B-21P6G1-18.0	M83513/08-B03	MCDR3-B-15P6G9-18.0
M83513/06-E	MCDR3-B-31PS	M83513/08-D01	MCDR3-B-25P6G1-18.0	M83513/08-C03	MCDR3-B-21P6G9-18.0
M83513/06-F	MCDR3-B-37PS	M83513/08-E01	MCDR3-B-31P6G1-18.0	M83513/08-D03	MCDR3-B-25P6G9-18.0
M83513/06-G	MCDR3-B-51PS	M83513/08-F01	MCDR3-B-37P6G1-18.0	M83513/08-E03	MCDR3-B-31P6G9-18.0
M83513/07-A	MCDR3-B- 9SS	M83513/08-G01	MCDR3-B-51P6G1-18.0	M83513/08-F03	MCDR3-B-37P6G9-18.0
M83513/07-B	MCDR3-B-15SS	M83513/08-A02	MCDR3-B- 9P6G1-36.0	M83513/08-G03	MCDR3-B-51P6G9-18.0
M83513/07-C	MCDR3-B-21SS	M83513/08-B02	MCDR3-B-15P6G1-36.0	M83513/08-A04	MCDR3-B- 9P6G9-36.0
M83513/07-D	MCDR3-B-25SS	M83513/08-C02	MCDR3-B-21P6G1-36.0	M83513/08-B04	MCDR3-B-15P6G9-36.0
M83513/07-E	MCDR3-B-31SS	M83513/08-D02	MCDR3-B-25P6G1-36.0	M83513/08-C04	MCDR3-B-21P6G9-36.0
M83513/07-F	MCDR3-B-37SS	M83513/08-E02	MCDR3-B-31P6G1-36.0	M83513/08-D04	MCDR3-B-25P6G9-36.0

**MIL-DTL-83513 Cross Reference (Continued)**

**MCDR (Plastic Shell) (Continued)**

Military Part No.	MICRODOT Part No.
M83513/08-E04	MCDR3-B-31P6G9-36.0
M83513/08-F04	MCDR3-B-37P6G9-36.0
M83513/08-G04	MCDR3-B-51P6G9-36.0
M83513/08-A05	MCDR3-B- 9P5L4-0.5
M83513/08-B05	MCDR3-B-15P5L4-0.5
M83513/08-C05	MCDR3-B-21P5L4-0.5
M83513/08-D05	MCDR3-B-25P5L4-0.5
M83513/08-E05	MCDR3-B-31P5L4-0.5
M83513/08-F05	MCDR3-B-37P5L4-0.5
M83513/08-G05	MCDR3-B-51P5L4-0.5
M83513/08-A06	MCDR3-B- 9P5L4-1.0
M83513/08-B06	MCDR3-B-15P5L4-1.0
M83513/08-C06	MCDR3-B-21P5L4-1.0
M83513/08-D06	MCDR3-B-25P5L4-1.0
M83513/08-E06	MCDR3-B-31P5L4-1.0
M83513/08-F06	MCDR3-B-37P5L4-1.0
M83513/08-G06	MCDR3-B-51P5L4-1.0
M83513/08-A07	MCDR3-B- 9P5L5-0.5
M83513/08-B07	MCDR3-B-15P5L5-0.5
M83513/08-C07	MCDR3-B-21P5L5-0.5
M83513/08-D07	MCDR3-B-25P5L5-0.5
M83513/08-E07	MCDR3-B-31P5L5-0.5
M83513/08-F07	MCDR3-B-37P5L5-0.5
M83513/08-G07	MCDR3-B-51P5L5-0.5
M83513/08-A08	MCDR3-B- 9P5L5-1.0
M83513/08-B08	MCDR3-B-15P5L5-1.0
M83513/08-C08	MCDR3-B-21P5L5-1.0
M83513/08-D08	MCDR3-B-25P5L5-1.0
M83513/08-E08	MCDR3-B-31P5L5-1.0
M83513/08-F08	MCDR3-B-37P5L5-1.0
M83513/08-G08	MCDR3-B-51P5L5-1.0
M83513/08-A09	MCDR3-B- 9P6Q1-18.0
M83513/08-B09	MCDR3-B-15P6Q1-18.0
M83513/08-C09	MCDR3-B-21P6Q1-18.0
M83513/08-D09	MCDR3-B-25P6Q1-18.0
M83513/08-E09	MCDR3-B-31P6Q1-18.0
M83513/08-F09	MCDR3-B-37P6Q1-18.0
M83513/08-G09	MCDR3-B-51P6Q1-18.0
M83513/08-A10	MCDR3-B- 9P6Q1-36.0
M83513/08-B10	MCDR3-B-15P6Q1-36.0
M83513/08-C10	MCDR3-B-21P6Q1-36.0
M83513/08-D10	MCDR3-B-25P6Q1-36.0
M83513/08-E10	MCDR3-B-31P6Q1-36.0
M83513/08-F10	MCDR3-B-37P6Q1-36.0
M83513/08-G10	MCDR3-B-51P6Q1-36.0
M83513/08-A11	MCDR3-B- 9P6Q9-18.0
M83513/08-B11	MCDR3-B-15P6Q9-18.0
M83513/08-C11	MCDR3-B-21P6Q9-18.0
M83513/08-D11	MCDR3-B-25P6Q9-18.0
M83513/08-E11	MCDR3-B-31P6Q9-18.0
M83513/08-F11	MCDR3-B-37P6Q9-18.0
M83513/08-G11	MCDR3-B-51P6Q9-18.0
M83513/08-A12	MCDR3-B- 9P6Q9-36.0
M83513/08-B12	MCDR3-B-15P6Q9-36.0
M83513/08-C12	MCDR3-B-21P6Q9-36.0
M83513/08-D12	MCDR3-B-25P6Q9-36.0
M83513/08-E12	MCDR3-B-31P6Q9-36.0
M83513/08-F12	MCDR3-B-37P6Q9-36.0
M83513/08-G12	MCDR3-B-51P6Q9-36.0
M83513/08-A13	MCDR3-B- 9P6G1-72.0

Military Part No.	MICRODOT Part No.
M83513/08-B13	MCDR3-B-15P6G1-72.0
M83513/08-C13	MCDR3-B-21P6G1-72.0
M83513/08-D13	MCDR3-B-25P6G1-72.0
M83513/08-E13	MCDR3-B-31P6G1-72.0
M83513/08-F13	MCDR3-B-37P6G1-72.0
M83513/08-G13	MCDR3-B-51P6G1-72.0
M83513/08-A14	MCDR3-B- 9P6G9-72.0
M83513/08-B14	MCDR3-B-15P6G9-72.0
M83513/08-C14	MCDR3-B-21P6G9-72.0
M83513/08-D14	MCDR3-B-25P6G9-72.0
M83513/08-E14	MCDR3-B-31P6G9-72.0
M83513/08-F14	MCDR3-B-37P6G9-72.0
M83513/08-G14	MCDR3-B-51P6G9-72.0
M83513/08-A15	MCDR3-B- 9P6Q1-72.0
M83513/08-B15	MCDR3-B-15P6Q1-72.0
M83513/08-C15	MCDR3-B-21P6Q1-72.0
M83513/08-D15	MCDR3-B-25P6Q1-72.0
M83513/08-E15	MCDR3-B-31P6Q1-72.0
M83513/08-F15	MCDR3-B-37P6Q1-72.0
M83513/08-G15	MCDR3-B-51P6Q1-72.0
M83513/08-A16	MCDR3-B- 9P6Q9-72.0
M83513/08-B16	MCDR3-B-15P6Q9-72.0
M83513/08-C16	MCDR3-B-21P6Q9-72.0
M83513/08-D16	MCDR3-B-25P6Q9-72.0
M83513/08-E16	MCDR3-B-31P6Q9-72.0
M83513/08-F16	MCDR3-B-37P6Q9-72.0
M83513/08-G16	MCDR3-B-51P6Q9-72.0
M83513/09-A01	MCDR3-B- 9S6G1-18.0
M83513/09-B01	MCDR3-B-15S6G1-18.0
M83513/09-C01	MCDR3-B-21S6G1-18.0
M83513/09-D01	MCDR3-B-25S6G1-18.0
M83513/09-E01	MCDR3-B-31S6G1-18.0
M83513/09-F01	MCDR3-B-37S6G1-18.0
M83513/09-G01	MCDR3-B-51S6G1-18.0
M83513/09-A02	MCDR3-B- 9S6G1-36.0
M83513/09-B02	MCDR3-B-15S6G1-36.0
M83513/09-C02	MCDR3-B-21S6G1-36.0
M83513/09-D02	MCDR3-B-25S6G1-36.0
M83513/09-E02	MCDR3-B-31S6G1-36.0
M83513/09-F02	MCDR3-B-37S6G1-36.0
M83513/09-G02	MCDR3-B-51S6G1-36.0
M83513/09-A03	MCDR3-B- 9S6G9-18.0
M83513/09-B03	MCDR3-B-15S6G9-18.0
M83513/09-C03	MCDR3-B- 21S6G9-18.0
M83513/09-D03	MCDR3-B-25S6G9-18.0
M83513/09-E03	MCDR3-B-31S6G9-18.0
M83513/09-F03	MCDR3-B-37S6G9-18.0
M83513/09-G03	MCDR3-B-51S6G9-18.0
M83513/09-A04	MCDR3-B- 9S6G9-36.0
M83513/09-B04	MCDR3-B-15S6G9-36.0
M83513/09-C04	MCDR3-B-21S6G9-36.0
M83513/09-D04	MCDR3-B-25S6G9-36.0
M83513/09-E04	MCDR3-B-31S6G9-36.0
M83513/09-F04	MCDR3-B-37S6G9-36.0
M83513/09-G04	MCDR3-B-51S6G9-36.0
M83513/09-A05	MCDR3-B- 9S5L4-0.5
M83513/09-B05	MCDR3-B-15S5L4-0.5
M83513/09-C05	MCDR3-B-21S5L4-0.5
M83513/09-D05	MCDR3-B-25S5L4-0.5
M83513/09-E05	MCDR3-B-31S5L4-0.5

Military Part No.	MICRODOT Part No.
M83513/09-F05	MCDR3-B-37S5L4-0.5
M83513/09-G05	MCDR3-B-51S5L4-0.5
M83513/09-A06	MCDR3-B- 9S5L4-1.0
M83513/09-B06	MCDR3-B-15S5L4-1.0
M83513/09-C06	MCDR3-B-21S5L4-1.0
M83513/09-D06	MCDR3-B-25S5L4-1.0
M83513/09-E06	MCDR3-B-31S5L4-1.0
M83513/09-F06	MCDR3-B-37S5L4-1.0
M83513/09-G06	MCDR3-B-51S5L4-1.0
M83513/09-A07	MCDR3-B- 9S5L5-0.5
M83513/09-B07	MCDR3-B-15S5L5-0.5
M83513/09-C07	MCDR3-B-21S5L5-0.5
M83513/09-D07	MCDR3-B-25S5L5-0.5
M83513/09-E07	MCDR3-B-31S5L5-0.5
M83513/09-F07	MCDR3-B-37S5L5-0.5
M83513/09-G07	MCDR3-B-51S5L5-0.5
M83513/09-A08	MCDR3-B- 9S5L5-1.0
M83513/09-B08	MCDR3-B-15S5L5-1.0
M83513/09-C08	MCDR3-B-21S5L5-1.0
M83513/09-D08	MCDR3-B-25S5L5-1.0
M83513/09-E08	MCDR3-B-31S5L5-1.0
M83513/09-F08	MCDR3-B-37S5L5-1.0
M83513/09-G08	MCDR3-B-51S5L5-1.0
M83513/09-A09	MCDR3-B- 9S6Q1-18.0
M83513/09-B09	MCDR3-B-15S6Q1-18.0
M83513/09-C09	MCDR3-B-21S6Q1-18.0
M83513/09-D09	MCDR3-B-25S6Q1-18.0
M83513/09-E09	MCDR3-B-31S6Q1-18.0
M83513/09-F09	MCDR3-B-37S6Q1-18.0
M83513/09-G09	MCDR3-B-51S6Q1-18.0
M83513/09-A10	MCDR3-B- 9S6Q1-36.0
M83513/09-B10	MCDR3-B-15S6Q1-36.0
M83513/09-C10	MCDR3-B-21S6Q1-36.0
M83513/09-D10	MCDR3-B-25S6Q1-36.0
M83513/09-E10	MCDR3-B-31S6Q1-36.0
M83513/09-F10	MCDR3-B-37S6Q1-36.0
M83513/09-G10	MCDR3-B-51S6Q1-36.0
M83513/09-A11	MCDR3-B- 9S6Q9-18.0
M83513/09-B11	MCDR3-B-15S6Q9-18.0
M83513/09-C11	MCDR3-B-21S6Q9-18.0
M83513/09-D11	MCDR3-B-25S6Q9-18.0
M83513/09-E11	MCDR3-B-31S6Q9-18.0
M83513/09-F11	MCDR3-B-37S6Q9-18.0
M83513/09-G11	MCDR3-B-51S6Q9-18.0
M83513/09-A12	MCDR3-B- 9S6Q9-36.0
M83513/09-B12	MCDR3-B-15S6Q9-36.0
M83513/09-C12	MCDR3-B-21S6Q9-36.0
M83513/09-D12	MCDR3-B-25S6Q9-36.0
M83513/09-E12	MCDR3-B-31S6Q9-36.0
M83513/09-F12	MCDR3-B-37S6Q9-36.0
M83513/09-G12	MCDR3-B-51S6Q9-36.0
M83513/09-A13	MCDR3-B- 9S6G1-72.0
M83513/09-B13	MCDR3-B-15S6G1-72.0
M83513/09-C13	MCDR3-B-21S6G1-72.0
M83513/09-D13	MCDR3-B-25S6G1-72.0
M83513/09-E13	MCDR3-B-31S6G1-72.0
M83513/09-F13	MCDR3-B-37S6G1-72.0
M83513/09-G13	MCDR3-B-51S6G1-72.0
M83513/09-A14	MCDR3-B- 9S6G9-72.0
M83513/09-B14	MCDR3-B-15S6G9-72.0

**MIL-DTL-83513 Cross Reference** (Continued)

**MCDR (Plastic Shell)** (Continued)

Military Part No.	MICRODOT Part No.
M83513/09-C14	MCDR3-B-21S6G9-72.0
M83513/09-D14	MCDR3-B-25S6G9-72.0
M83513/09-E14	MCDR3-B-31S6G9-72.0
M83513/09-F14	MCDR3-B-37S6G9-72.0
M83513/09-G14	MCDR3-B-51S6G9-72.0
M83513/09-A15	MCDR3-B- 9S6Q1-72.0
M83513/09-B15	MCDR3-B-15S6Q1-72.0

Military Part No.	MICRODOT Part No.
M83513/09-C15	MCDR3-B-21S6Q1-72.0
M83513/09-D15	MCDR3-B-25S6Q1-72.0
M83513/09-E15	MCDR3-B-31S6Q1-72.0
M83513/09-F15	MCDR3-B-37S6Q1-72.0
M83513/09-G15	MCDR3-B-51S6Q1-72.0
M83513/09-A16	MCDR3-B- 9S6Q9-72.0
M83513/09-B16	MCDR3-B-15S6Q9-72.0

Military Part No.	MICRODOT Part No.
M83513/09-C16	MCDR3-B-21S6Q9-72.0
M83513/09-D16	MCDR3-B-25S6Q9-72.0
M83513/09-E16	MCDR3-B-31S6Q9-72.0
M83513/09-F16	MCDR3-B-37S6Q9-72.0
M83513/09-G16	MCDR3-B-51S6Q9-72.0

**MCK (Metal Shell)**

Military Part No.	MICRODOT Part No.
M83513/10-A01*N	MCK**-B- 9PRT1
M83513/10-B01*N	MCK**-B- 15PRT1
M83513/10-C01*N	MCK**-B- 21PRT1
M83513/10-D01*N	MCK**-B- 25PRT1
M83513/10-E01*N	MCK**-B- 31PRT1
M83513/10-F01*N	MCK**-B- 37PRT1
M83513/10-A01*P	MCK**-P- 9PRT1
M83513/10-B01*P	MCK**-P- 15PRT1
M83513/10-C01*P	MCK**-P- 21PRT1
M83513/10-D01*P	MCK**-P- 25PRT1
M83513/10-E01*P	MCK**-P- 31PRT1
M83513/10-F01*P	MCK**-P- 37PRT1
M83513/10-A02*N	MCK**-B- 9PRT1A
M83513/10-B02*N	MCK**-B- 15PRT1A
M83513/10-C02*N	MCK**-B- 21PRT1A
M83513/10-D02*N	MCK**-B- 25PRT1A
M83513/10-E02*N	MCK**-B- 31PRT1A
M83513/10-F02*N	MCK**-B- 37PRT1A
M83513/10-A02*P	MCK**-P- 9PRT1A
M83513/10-B02*P	MCK**-P- 15PRT1A
M83513/10-C02*P	MCK**-P- 21PRT1A
M83513/10-D02*P	MCK**-P- 25PRT1A
M83513/10-E02*P	MCK**-P- 31PRT1A
M83513/10-F02*P	MCK**-P- 37PRT1A
M83513/10-A03*N	MCK**-B- 9PRT1B
M83513/10-B03*N	MCK**-B- 15PRT1B
M83513/10-C03*N	MCK**-B- 21PRT1B
M83513/10-D03*N	MCK**-B- 25PRT1B
M83513/10-E03*N	MCK**-B- 31PRT1B
M83513/10-F03*N	MCK**-B- 37PRT1B
M83513/10-A03*P	MCK**-P- 9PRT1B
M83513/10-B03*P	MCK**-P- 15PRT1B
M83513/10-C03*P	MCK**-P- 21PRT1B
M83513/10-D03*P	MCK**-P- 25PRT1B
M83513/10-E03*P	MCK**-P- 31PRT1B
M83513/10-F03*P	MCK**-P- 37PRT1B
M83513/11-G01*N	MCK**-B- 51PRT1
M83513/11-G01*P	MCK**-P- 51PRT1
M83513/11-G02*N	MCK**-B- 51PRT1A
M83513/11-G02*P	MCK**-P- 51PRT1A
M83513/11-G03*N	MCK**-B- 51PRT1B
M83513/11-G03*P	MCK**-P- 51PRT1B
M83513/12-H01*N	MCK**-B-100PRT1
M83513/12-H01*P	MCK**-S-100PRT1
M83513/12-H02*N	MCK**-B-100PRT1A
M83513/12-H02*P	MCK**-S-100PRT1A
M83513/12-H03*N	MCK**-B-100PRT1B

Military Part No.	MICRODOT Part No.
M83513/12-H03*P	MCK**-S-100PRT1B
M83513/13-A01*N	MCK**-B- 9SRT1
M83513/13-B01*N	MCK**-B- 15SRT1
M83513/13-C01*N	MCK**-B- 21SRT1
M83513/13-D01*N	MCK**-B- 25SRT1
M83513/13-E01*N	MCK**-B- 31SRT1
M83513/13-F01*N	MCK**-B- 37SRT1
M83513/13-A01*P	MCK**-P- 9SRT1
M83513/13-B01*P	MCK**-P- 15SRT1
M83513/13-C01*P	MCK**-P- 21SRT1
M83513/13-D01*P	MCK**-P- 25SRT1
M83513/13-E01*P	MCK**-P- 31SRT1
M83513/13-F01*P	MCK**-P- 37SRT1
M83513/13-A02*N	MCK**-B- 9SRT1A
M83513/13-B02*N	MCK**-B- 15SRT1A
M83513/13-C02*N	MCK**-B- 21SRT1A
M83513/13-D02*N	MCK**-B- 25SRT1A
M83513/13-E02*N	MCK**-B- 31SRT1A
M83513/13-F02*N	MCK**-B- 37SRT1A
M83513/13-A02*P	MCK**-P- 9SRT1A
M83513/13-B02*P	MCK**-P- 15SRT1A
M83513/13-C02*P	MCK**-P- 21SRT1A
M83513/13-D02*P	MCK**-P- 25SRT1A
M83513/13-E02*P	MCK**-P- 31SRT1A
M83513/13-F02*P	MCK**-P- 37SRT1A
M83513/13-A03*N	MCK**-B- 9SRT1B
M83513/13-B03*N	MCK**-B- 15SRT1B
M83513/13-C03*N	MCK**-B- 21SRT1B
M83513/13-D03*N	MCK**-B- 25SRT1B
M83513/13-E03*N	MCK**-B- 31SRT1B
M83513/13-F03*N	MCK**-B- 37SRT1B
M83513/13-A03*P	MCK**-P- 9SRT1B
M83513/13-B03*P	MCK**-P- 15SRT1B
M83513/13-C03*P	MCK**-P- 21SRT1B
M83513/13-D03*P	MCK**-P- 25SRT1B
M83513/13-E03*P	MCK**-P- 31SRT1B
M83513/13-F03*P	MCK**-P- 37SRT1B
M83513/14-G01*N	MCK**-B- 51SRT1
M83513/14-G01*P	MCK**-P- 51SRT1
M83513/14-G02*N	MCK**-B- 51SRT1A
M83513/14-G02*P	MCK**-P- 51SRT1A
M83513/14-G03*N	MCK**-B- 51SRT1B
M83513/14-G03*P	MCK**-P- 51SRT1B
M83513/15-H01*N	MCK**-B-100SRT1
M83513/15-H01*P	MCK**-S-100SRT1
M83513/15-H02*N	MCK**-B-100SRT1A
M83513/15-H02*P	MCK**-S-100SRT1A

Military Part No.	MICRODOT Part No.
M83513/15-H03*N	MCK**-B-100SRT1B
M83513/15-H03*P	MCK**-S-100SRT1B
M83513/22-A01*N	MCK**-B- 9PST1
M83513/22-B01*N	MCK**-B- 15PST1
M83513/22-C01*N	MCK**-B- 21PST1
M83513/22-D01*N	MCK**-B- 25PST1
M83513/22-E01*N	MCK**-B- 31PST1
M83513/22-F01*N	MCK**-B- 37PST1
M83513/22-A01*P	MCK**-P- 9PST1
M83513/22-B01*P	MCK**-P- 15PST1
M83513/22-C01*P	MCK**-P- 21PST1
M83513/22-D01*P	MCK**-P- 25PST1
M83513/22-E01*P	MCK**-P- 31PST1
M83513/22-F01*P	MCK**-P- 37PST1
M83513/22-A02*N	MCK**-B- 9PST1A
M83513/22-B02*N	MCK**-B- 15PST1A
M83513/22-C02*N	MCK**-B- 21PST1A
M83513/22-D02*N	MCK**-B- 25PST1A
M83513/22-E02*N	MCK**-B- 31PST1A
M83513/22-F02*N	MCK**-B- 37PST1A
M83513/22-A02*P	MCK**-P- 9PST1A
M83513/22-B02*P	MCK**-P- 15PST1A
M83513/22-C02*P	MCK**-P- 21PST1A
M83513/22-D02*P	MCK**-P- 25PST1A
M83513/22-E02*P	MCK**-P- 31PST1A
M83513/22-F02*P	MCK**-P- 37PST1A
M83513/22-A03*N	MCK**-B- 9PST1B
M83513/22-B03*N	MCK**-B- 15PST1B
M83513/22-C03*N	MCK**-B- 21PST1B
M83513/22-D03*N	MCK**-B- 25PST1B
M83513/22-E03*N	MCK**-B- 31PST1B
M83513/22-F03*N	MCK**-B- 37PST1B
M83513/22-A03*P	MCK**-P- 9PST1B
M83513/22-B03*P	MCK**-P- 15PST1B
M83513/22-C03*P	MCK**-P- 21PST1B
M83513/22-D03*P	MCK**-P- 25PST1B
M83513/22-E03*P	MCK**-P- 31PST1B
M83513/22-F03*P	MCK**-P- 37PST1B
M83513/23-G01*N	MCK**-B- 51PST1
M83513/23-G01*P	MCK**-P- 51PST1
M83513/23-G02*N	MCK**-B- 51PST1A
M83513/23-G02*P	MCK**-P- 51PST1A
M83513/23-G03*N	MCK**-B- 51PST1B
M83513/23-G03*P	MCK**-P- 51PST1B
M83513/24-H01*N	MCK**-B-100PST1
M83513/24-H01*P	MCK**-S-100PST1
M83513/24-H02*N	MCK**-B-100PST1A

**MIL-DTL-83513 Cross Reference** (Continued)

**MCK (Metal Shell)** (Continued)

Military Part No.	MICRODOT Part No.	Military Part No.	MICRODOT Part No.	Military Part No.	MICRODOT Part No.
M83515/24-H02*P	MCK-**-S-100PST1A	M83513/25-C02*N	MCK-**-B- 21SST1A	M83513/25-B03*P	MCK-**-P- 15SST1B
M83513/24-H03*N	MCK-**-B-100PST1B	M83513/25-D02*N	MCK-**-B- 25SST1A	M83513/25-C03*P	MCK-**-P- 21SST1B
M83513/24-H03*P	MCK-**-S-100PST1B	M83513/25-E02*N	MCK-**-B- 31SST1A	M83513/25-D03*P	MCK-**-P- 25SST1B
M83513/25-A01*N	MCK-**-B- 9SST1	M83513/25-F02*N	MCK-**-B- 37SST1A	M83513/25-E03*P	MCK-**-P- 31SST1B
M83513/25-B01*N	MCK-**-B- 15SST1	M83513/25-A02*P	MCK-**-P- 9SST1A	M83513/25-F03*P	MCK-**-P- 37SST1B
M83513/25-C01*N	MCK-**-B- 21SST1	M83513/25-B02*P	MCK-**-P- 15SST1A	M83513/26-G01*N	MCK-**-B- 51SST1
M83513/25-D01*N	MCK-**-B- 25SST1	M83513/25-C02*P	MCK-**-P- 21SST1A	M83513/26-G01*P	MCK-**-P- 51SST1
M83513/25-E01*N	MCK-**-B- 31SST1	M83513/25-D02*P	MCK-**-P- 25SST1A	M83513/26-G02*N	MCK-**-B- 51SST1A
M83513/25-F01*N	MCK-**-B- 37SST1	M83513/25-E02*P	MCK-**-P- 31SST1A	M83513/26-G02*P	MCK-**-P- 51SST1A
M83513/25-A01*P	MCK-**-P- 9SST1	M83513/25-F02*P	MCK-**-P- 37SST1A	M83513/26-G03*N	MCK-**-B- 51SST1B
M83513/25-B01*P	MCK-**-P- 15SST1	M83513/25-A03*N	MCK-**-B- 9SST1B	M83513/26-G03*P	MCK-**-P- 51SST1B
M83513/25-C01*P	MCK-**-P- 21SST1	M83513/25-B03*N	MCK-**-B- 15SST1B	M83513/27-H01*N	MCK-**-B-100SST1
M83513/25-D01*P	MCK-**-P- 25SST1	M83513/25-C03*N	MCK-**-B- 21SST1B	M83513/27-H01*P	MCK-**-S-100SST1
M83513/25-E01*P	MCK-**-P- 31SST1	M83513/25-D03*N	MCK-**-B- 25SST1B	M83513/27-H02*N	MCK-**-B-100SST1A
M83513/25-F01*P	MCK-**-P- 37SST1	M83513/25-E03*N	MCK-**-B- 31SST1B	M83515/27-H02*P	MCK-**-S-100SST1A
M83513/25-A02*N	MCK-**-B- 9SST1A	M83513/25-F03*N	MCK-**-B- 37SST1B	M83513/27-H03*N	MCK-**-B-100SST1B
M83513/25-B02*N	MCK-**-B- 15SST1A	M83513/25-A03*P	MCK-**-P- 9SST1B	M83513/27-H03*P	MCK-**-S-100SST1B

\*C = Cadmium or N = Nickel (space applications only)  
 \*\*C2 = Cadmium or N1 = Nickel (space applications only)