

Nominal frequency (f₀) **49.152 MHz**

Performance Specifications

Parameter	Frequency stabilities			Units	Condition
	Min	Typical	Max		
Over all (df/f ₀)	-4.6		+4.6	ppm	-40...85°C include: Temp. Stab, supply, load stab, initial, 20 years aging
vs. operating temp. range (df/f@25°C)	-5		+5	ppb	-40...85°C
initial tolerance (df/f ₀)	-200		+200	ppb	@25 °C
vs. supply voltage change (df/f)	-3		+3	ppb	static; 3.3 V ±5 %
vs. load change (df/f)	-2		+2	ppb	static; Load +5 % -5 %
vs. aging / daily (df/f)	-1		+1	ppb	after 30 days ; @ 25 °C
vs. aging / month (df/f)	-40		+40	ppb	after 30 days ; @ 25 °C
vs. aging / year (df/f)	-100		+100	ppb	after 30 days ; @ 25 °C
Holdover/Drift	-1		+1	ppb	over 24 hours and ±2.8°C
			10	ppb [pk-pk]	over 24 hours; -40...85°C
Note:	S3E compliant according GR1244				

Parameter	RF output			Units	Condition
	Min	Typical	Max		
Signal	LVCMOS				
Load	13.5	15	16.5	pF	
Fan out					
Rise Time			5	ns	@10 to 90 %V _{out}
Fall Time			5	ns	@90 to 10 %V _{out}
Duty cycle	45		55	%	@1.65 V
V Low			0.4	V	
V High	2.4			V	
Sub Harmonics			-40	dBc	
Spurious			-90	dBc	

Supply voltage					
Parameter	Min	Typical	Max	Units	Condition
Supply voltage (Vs)	3.14	3.3	3.47	V	
Current consumption steady state			400	mA	@ Vsnom & 25 °C
			700	mA	@ Vsnom & -40 °C
Current consumption during warm up			1200	mA	@ Vs

Additional Parameters					
Parameter	Min	Typical	Max	Units	Condition
Warm up time			5	min	@ 25 °C to final frequency
Phase Noise		-77		dBc/Hz	@1Hz
		-107		dBc/Hz	@10Hz
		-135		dBc/Hz	@100Hz
		-146		dBc/Hz	@1kHz
		-150		dBc/Hz	@10kHz
		-150		dBc/Hz	@100kHz
Jitter			0.3	psec (RMS)	@ 12kHz to 5MHz
MTIE		0.2		ns	1.0 sec
		2		ns	10.0 sec
		10		ns	100.0 sec
		30		ns	1000.0 sec
TDEV		0.003 ns			1 s
		0.04 ns			10 s
		0.4 ns			100 s
Additional information	wander generation tdev & mtie at 1 mHz constant temp: meets GR-1244 mask				
	wander generation tdev & mtie at 1 mHz variable temp: meets GR-1244 mask				
Processing & Packing	handling&processing note				

Additional Environmental Conditions	
Parameter	Description
RoHS compliance	100% RoHS 6 compliant
Washable	washable device
ESD HBM	JESD22-A114F Class 1C - 10* 2000V
Mechanical Shock	MIL-STD-202 Meth 213B Cond. C - 100g 6ms 6 shocks in each direction
Vibration, Sine	JESD22-B103 Cond.2 - 10g 10-2000Hz 4x in each 3 axis 4min sweep time
Moisture Sen. Level	JESD22-A113-B - only if > MSL 1
Solderability	J-STD-002C Cond. A, Trough hole device; Cond.B, SMD (correspond to MIL-STD-883 Meth 2003) - 255°C (diving Time 5 ±0,5sec.) Dip&Look with 8h damp pre-treatment: solder wetting >95%
High temp operating life(HTOL)	MIL-STD-202 Meth108A Cond C - 1000h @ 105°C under voltage
Low temp operating life(LTOL)	IEC 60068-2-1 Cond. Ae - Ta= -40°C, >1000 hours with bias for OCXO
Reflow Simulation Test	MIL-STD-202G Meth 210F Cond. K - Total 3x Lead free profile (for SMD)
Temperature Cycling	MIL-STD-883G Meth.1010.8 Cond.B - 1000cycles -55/+125°C; cycle time 30 min.

Absolute Maximum Ratings

Parameter	Min	Typical	Max	Units	Condition
Supply voltage (Vs)			5.5	V	
Operable temperature range	-40		+85	°C	
Storage temperature range	-40		+85	°C	

Enclosure

G275

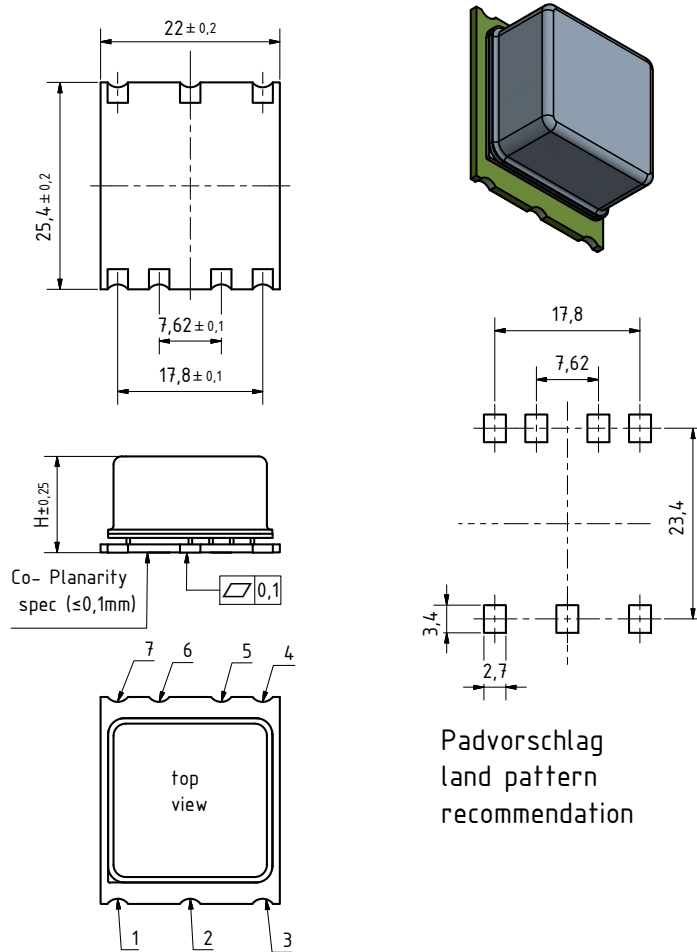

all units in mm

Enclosure Info

Parameter	Description
Type	G275D
Height	12.1 mm
Weight	9 g

Enclosure Info	
Parameter	Description
Pin Connections	1: I.C. (Do not connect) 2: N.C. 3: Vs (supply voltage input) 4: RF-Output 5: N.C. 6: N.C. 7: GND
Marking	OX-221-9102 49,152 MHz Ser.No. AYYWW * * pin-1 marking
Package cover material	Metal
Package base material	Metal

Solder profile

TP: max 260°C (@ solder joint, customer board level)

T_p: max: 10...30 sec

Additional Information:

This SMD oscillator has been designed for pick and place reflow soldering

SMD oscillators must be on the top side of the PCB during the reflow process.

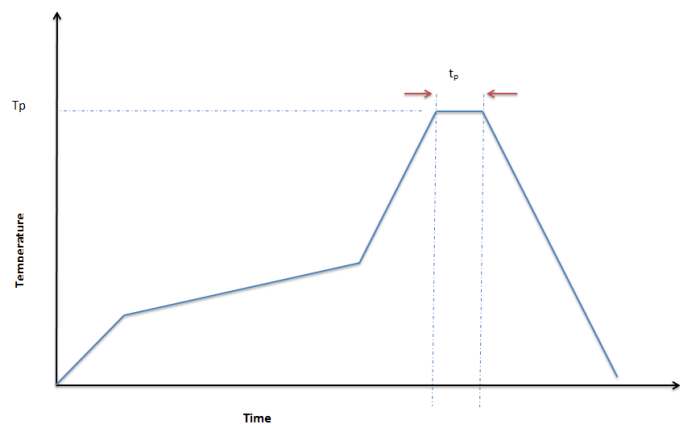

Standard shipping method

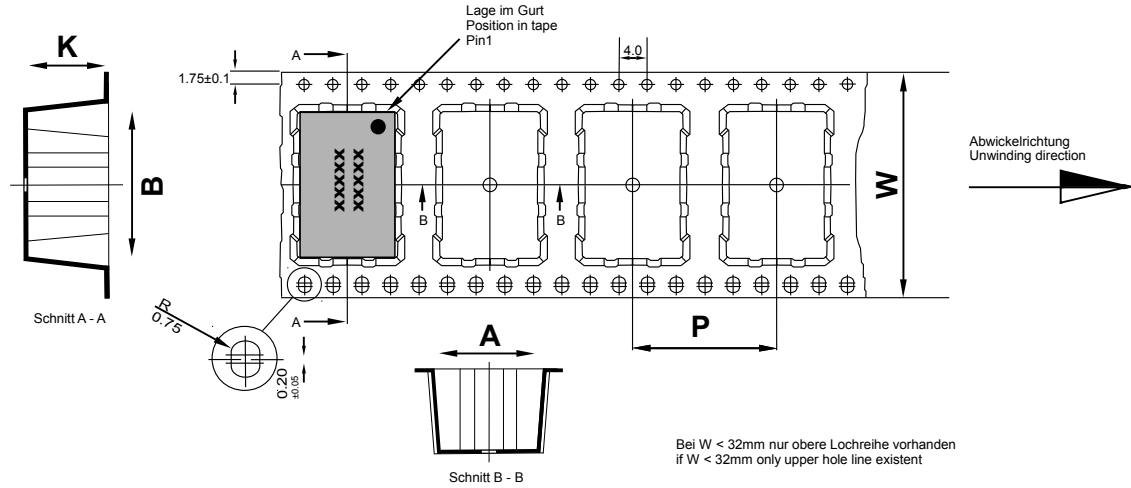

<p>Maßangaben in mm: A, B und K Maße von Bauelement abhängig Fertigungstoleranzen entsprechen der DIN IEC 286-3</p>	<p>Dimension in mm: A, B und K are dependent upon component dimensions production tolerance complying DIN IEC 286-3</p>
All dimensions in millimeters unless otherwise stated	

Tape Info						
Tape width W [mm]	Quantity per meter	Quantity per reel	P [mm]	A [mm]	B [mm]	K [mm]
44	35.7	175	28	22.5	25.9	12.8

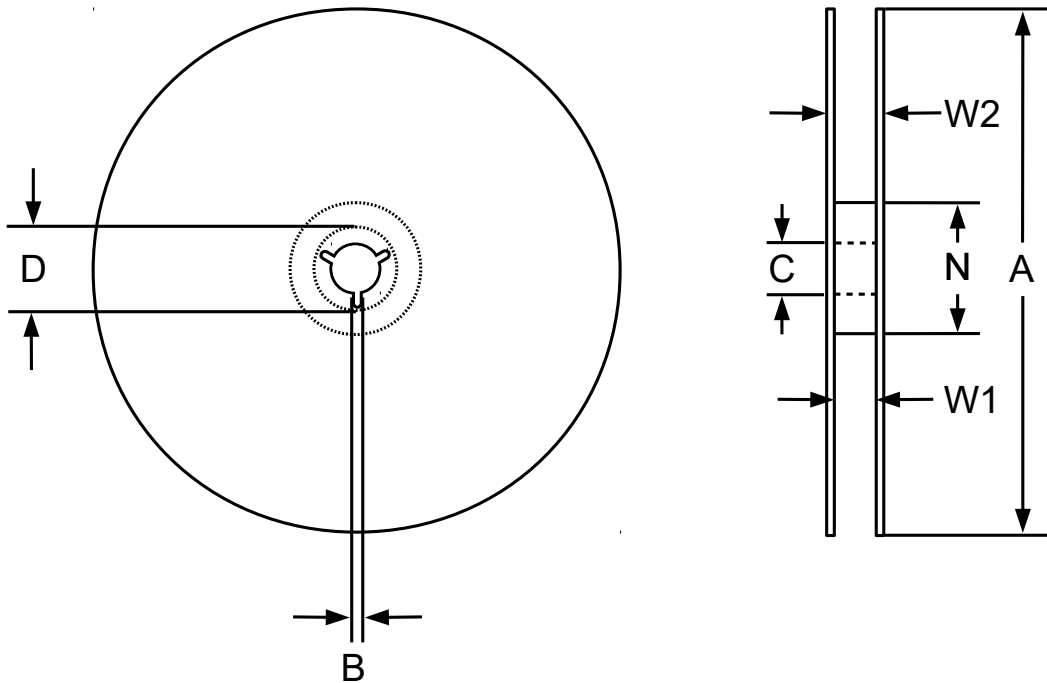

Reel Info						
A [mm]	B [mm]	Size C [mm]	D [mm]	N [mm]	W1 [mm]	W2 [mm]
330	1.5	13	20.2	100	45.5	49.1

Notes: Unless otherwise stated all values are valid after warm-up time and refer to typical conditions for supply voltage, frequency control voltage, load, temperature (25°C). Subject to technical modification.

For Additional Information, Please Contact

USA:

Vectron International
267 Lowell Road, Suite 102
Hudson, NH 03051
Tel: 1.888.328.7661
Fax: 1.888.329.8328

Europe:

Vectron International
Landstrasse, D-74924
Neckarbischofsheim, Germany
Tel: +49 (0) 7268.801.100
Fax: +49 (0) 7268.801.282

Asia:

Vectron International
68 Yin Cheng Road(C), 22nd Floor
One LuJiaZui
Pudong, Shanghai 200120, China
Tel: +86 21 6194 6886
Fax: +86 21 6194 6699

Disclaimer

Vectron International reserves the right to make changes to the product(s) and or information contained herein without notice. No liability is assumed as a result of their use or application. No rights under any patent accompany the sale of any such product(s) or information.

List of appendices

Appendix_OX-221-9102_49M152

II

Typical Performance Data

Typical MTIE

OX-221-9102-49M152

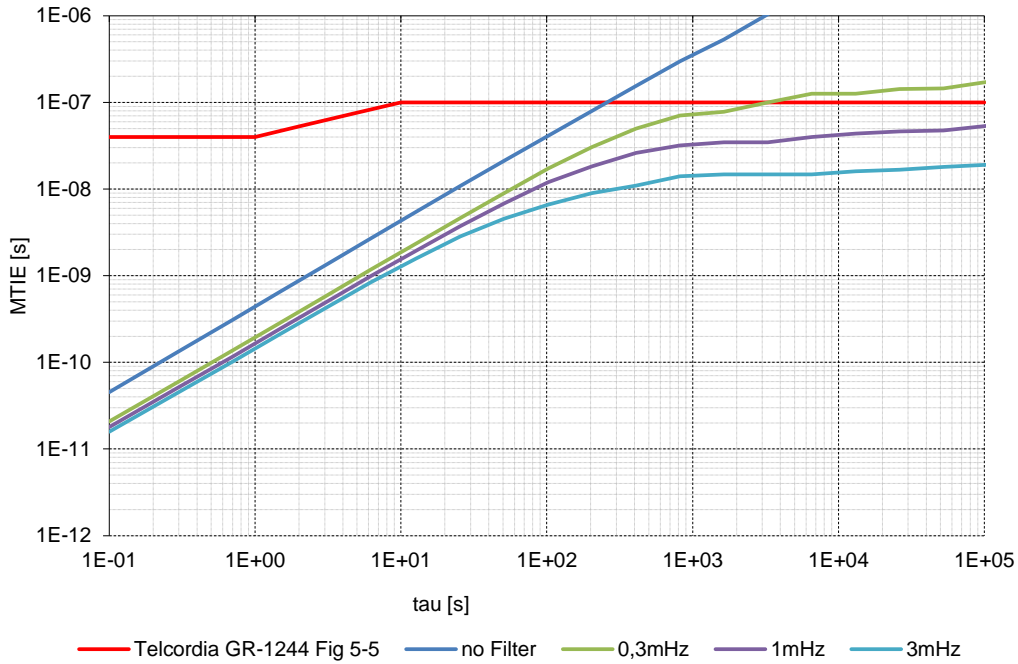

Typical TDEV

OX-221-9102-49M152

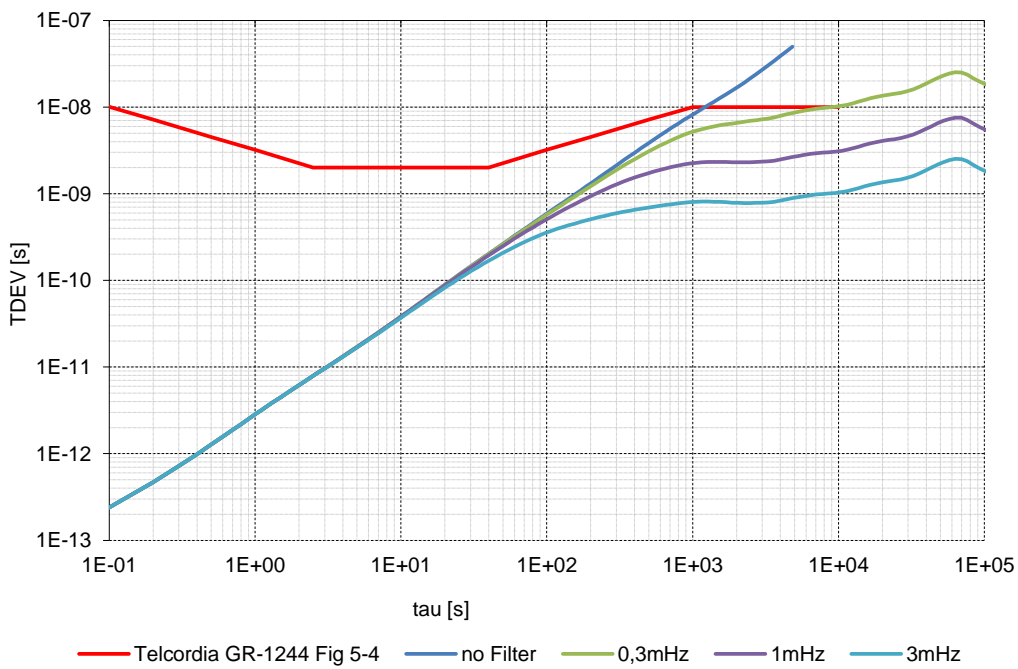

Filtered (0,3mHz; 1mHz; 3mHz) curves are simulated base on measured frequency / Phase data

Typical Phase Noise and Jitter

OX-221-9102-49M152

Agilent E5052B Signal Source Analyzer

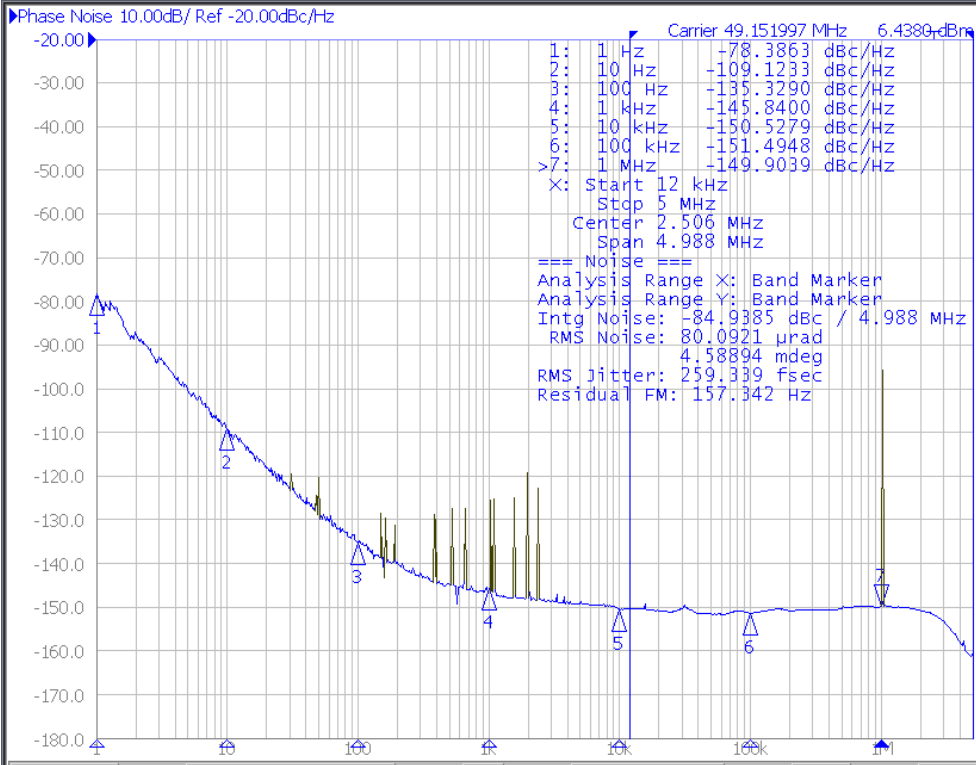

Resize

Average

Averaging
Restart

Avg Factor
8

Averaging
ON

Correlation
4

Return

IF Gain 40dB Freq Band [39M-101MHz] Spur LO Opt [<150kHz] 865pts Corre 4

Phase Noise Start 1 Hz Stop 5 MHz 8/8 34.5%

Phase Noise: Meas Cor Ctrl 1.65V Pow 3.3V Attn 5dB ExtRef1 ExtRef2 Stop Svc 2016-09-08 10:48